

OPERATOR INSTRUCTIONS

NP 300/500-NS 300 NARROW AISLE TRUCK W/WO REACH

2000 THRU 4500 LBS. RATED CAPACITIES

**CLARK
EQUIPMENT**

CLARK EQUIPMENT COMPANY / INDUSTRIAL TRUCK DIVISION
BATTLE CREEK, MICHIGAN 49016

TABLE OF CONTENTS

	Page
Foreword	1
Major Component Identification	2-3
Safe Operating Rules and Practices	4-15
Operator's Compartment and Controls	16
Operator's "Before Operation" Checks	17-25
Operation	26-29
Parking Procedures	30-31
Notes	31-32
Handy Reference Data	33

FOREWORD

This manual will help the “Qualified Operator” become familiar with the trucks major components, its operating controls, special features and the function(s) of each.

This publication is not a training manual but rather, a guide to help the “Qualified Operator” to safe and efficient operation of a Clark Forklift Truck.

Operator training manuals are available at your Clark Dealer.

Clark Forklift Trucks are built to take hard work not abuse. They are built to be dependable, but – as with any other vehicle – they are only as good as the man behind the wheel and the men responsible for maintaining them.

Illustrations in this manual guide the operator through correct procedures of checking, starting, operating and stopping the lift truck.

Read it – Study it – Keep it handy.

Know Your Truck

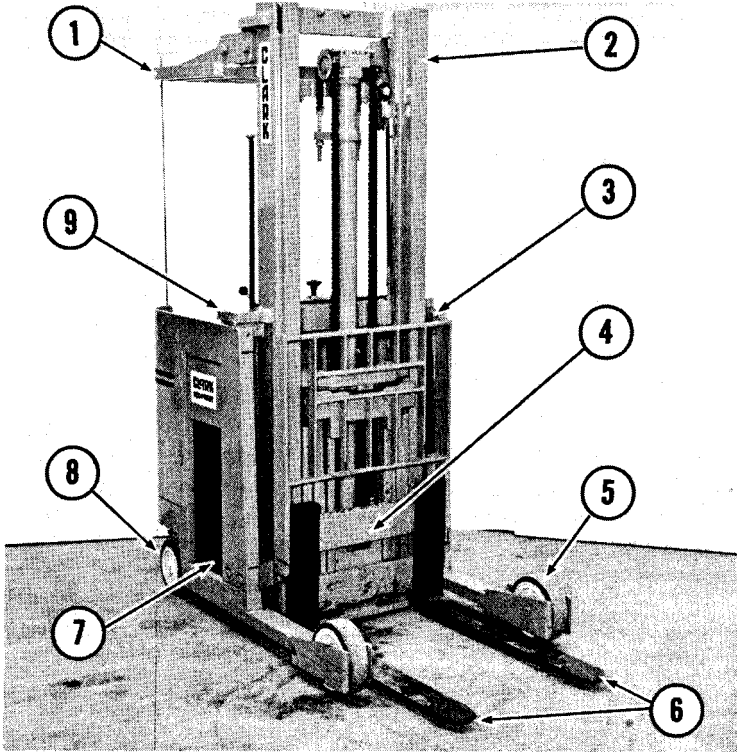

1. Overhead Guard.
2. Upright Assembly.
3. Load Backrest Extension.
4. Fork Carriage.
5. Load Wheels.
6. Load Forks.
7. Battery Compartment.
8. Drive and Steer Wheels.
9. Operator's Compartment.

14941

NP500

Narrow Aisle Reach Truck
2500/3500/4500 Lb. Rated Capacities

Know Your Truck

1. Overhead Guard.
2. Upright Assembly.
3. Load Backrest Extension.
4. Fork Carriage.
5. Load Wheels (NP model shown NS model as shown on page 19).
6. Load Forks.
7. Pantograph Mechanism (NP only).
8. Swivel Caster.
9. Battery Compartment.
10. Operator's Compartment and Controls.

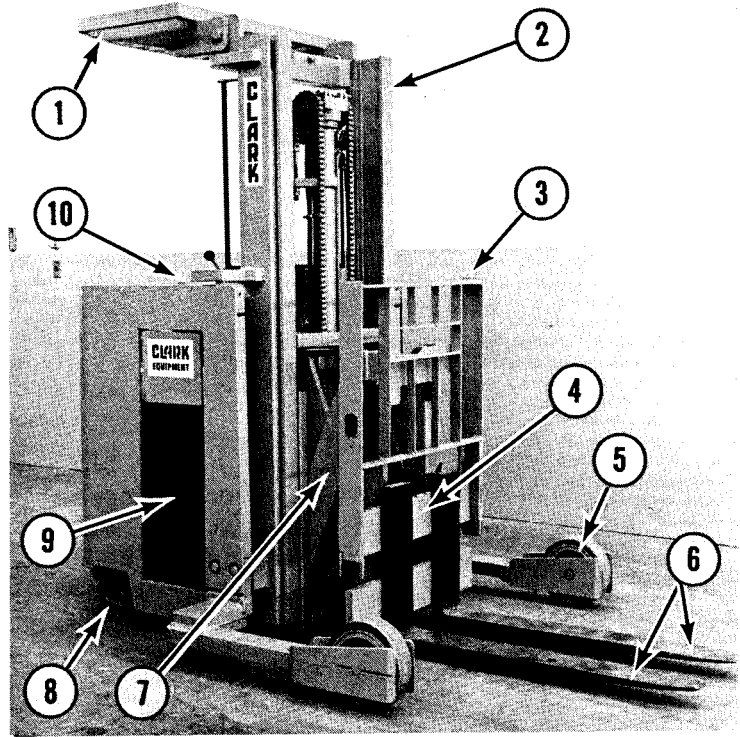

NS/NP300
Narrow Aisle Trucks
with (NP) or Without (NS) Reach
2000/3000/4000 Lbs. Rated Capacities

16788

Safety

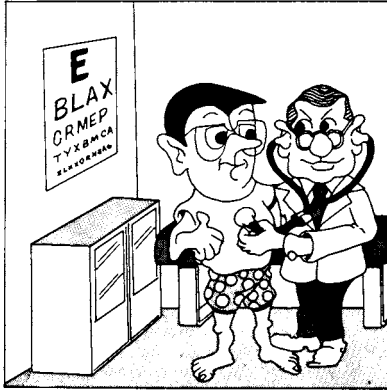

13696

14662

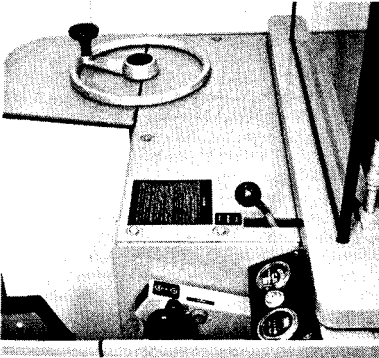

Page 4

1. Only physically qualified and thoroughly trained personnel shall be authorized to operate powered lift trucks.

3. Learn how your truck is operated. Know its safety devices, how they function and how the special attachments, if any, work.

2. Prominently placed on every Clark truck is a list of basic rules for operation. These rules are for the protection of you and others in your operating area. Be familiar with them. And obey them at all times.

4. The wearing of "hard hats", safety glasses and safety shoes is recommended. Dress suitably and avoid loose fitting clothing.

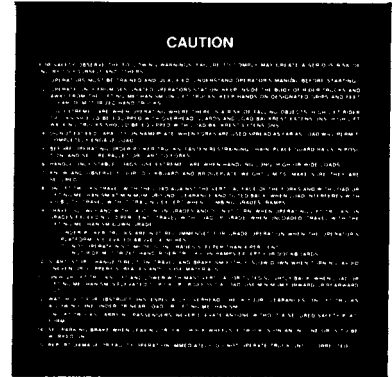

13110

14962

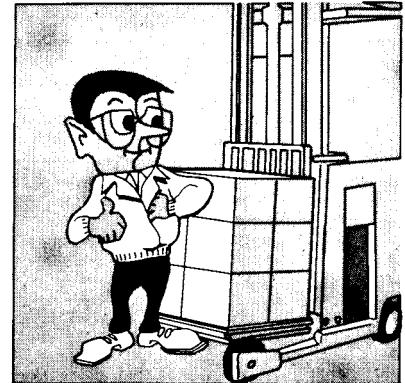

Code: OI-374 APR 75

Safety

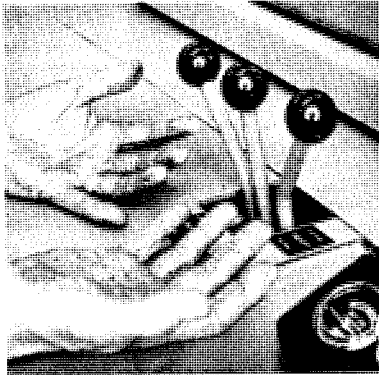

14663

5. Never operate a lift truck with wet or greasy hands or shoes.

6. Before operating any lift truck, test the horn, brakes, steering, hydraulic controls, directional controls, speed controls and special attachments, if any, for proper operation. Report any unusual or improper operation to designated authority immediately.

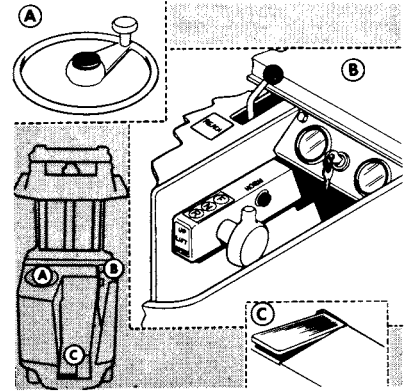

14963

14646



7. Always look all around the truck before moving it in any direction. Then remember to start and stop slowly and smoothly.

8. Operate the truck only in designated truck routes and keep operating aisles clear. One-way traffic is recommended. If this is not practical in your operation heed highway regulations and drive to right of aisle centerline.

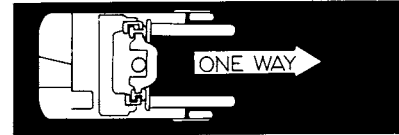

14964

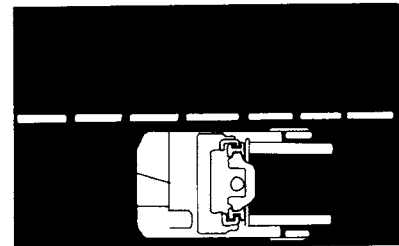

Safety

9. Be alert for pedestrians, other trucks or obstacles in your path of travel.

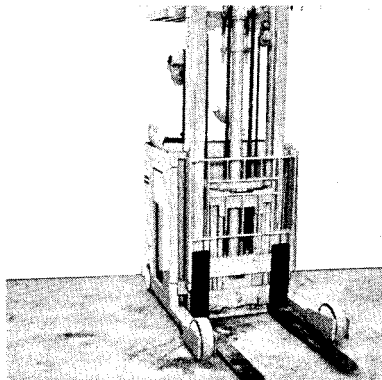

14664

10. Sound horn at all corners, exits, entrances and when approaching pedestrians or bystanders.

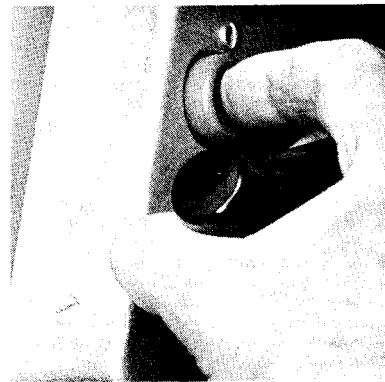

14647

13087



11. Obey all posted traffic rules and warning signs.

12. Maintain a safe distance from the truck ahead of you at all times.

Assure ample distance to stop smoothly and safely should the need arise.

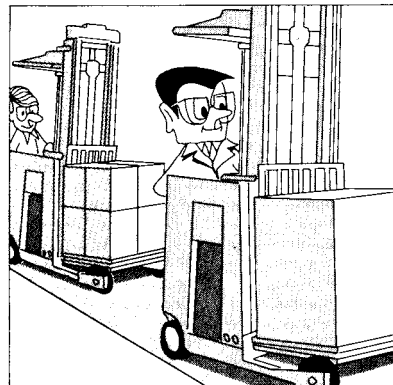

14965

Safety



14958

13. Be aware of rear end swing and be alert to prevent rear end swing damage to material in your operating area.

14. Always be sure of the position of your fork tips and load wheels when truck is in motion. Be alert to avoid striking anything with fork tips or load wheel outriggers.

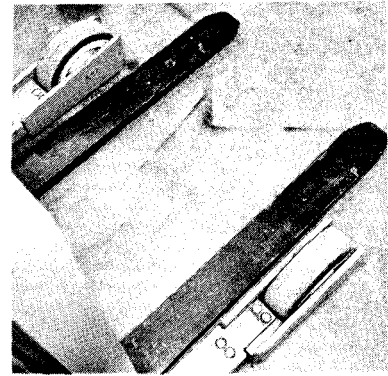

14665

14959

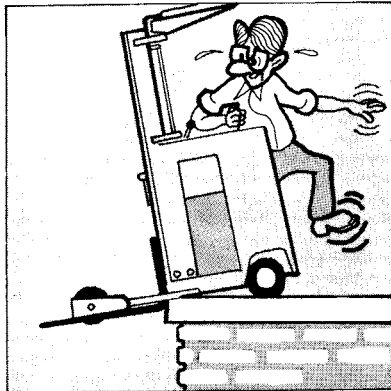

15. Be extremely cautious when operating truck near edge of loading dock.

16. Make sure vehicle being entered has been blocked to prevent accidental roll. Bridge plates must have adequate strength, width, guard rails each side (minimum 3" high recommended), and be properly secured.

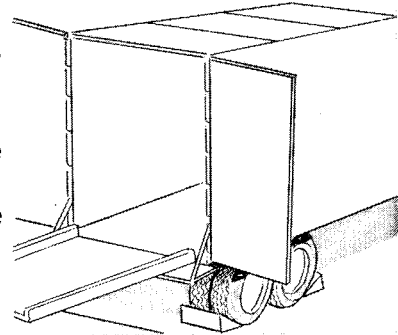

13146

Safety

17. Never allow stunt riding or indulge in horseplay while operating a fork lift truck.



14960

14946



19. Never carry unauthorized passengers. The quick response of a lift truck may cause riders to fall off. Besides, they distract you and this is dangerous.

18. Never use your truck to push or tow another. Never allow your truck to be pushed or towed by another.

Should a truck become disabled and require moving, notify the proper authority immediately.

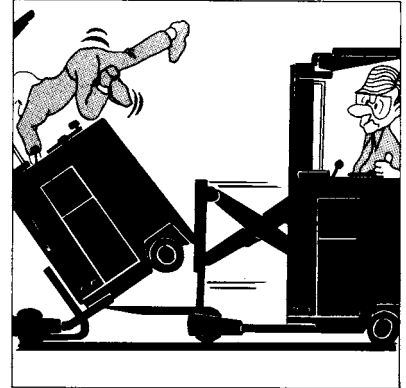

14961

20. Know the rated capacity of your truck and its attachment (if any) and never exceed it. Study your truck data capacity plate and learn the facts stamped in areas 1 through 8. Note information stamped in area 3 and refer to item 46 on page 15.

13095

CLARK EQUIPMENT		1	
INDUSTRIAL TRUCK DIVISION		BATTLE CREEK MICH	
MODEL NO.	2	TYPE	3
SERIAL NO.		4	
ATTACHMENTS		5	
		CAPACITY WITH ATTACH LISTED ABOVE OR WITH FORMS UPRIGHTS VERTICAL	
		LBS	A B C
APPROX. WT. ALL TRUCKS		6	
APPROX. WT. ELECTRICS ONLY		WITH MAX. BATT. WT.	
BATTERY CAPACITY		MAX	MIN
		AH	NO.
		LBS	VOLTS
8			
<small>FOR OTHER CAPACITIES CONSULT MANUFACTURER AS RELEASED FROM FACTORY THIS TRUCK MEETS THE DESIGN SPECIFICATIONS ESTABLISHED IN AMERICAN NATIONAL STANDARD FOR POWERED INDUSTRIAL TRUCKS PART II ANSI B 56.1-1969 PT NO. 2315709</small>			

Safety

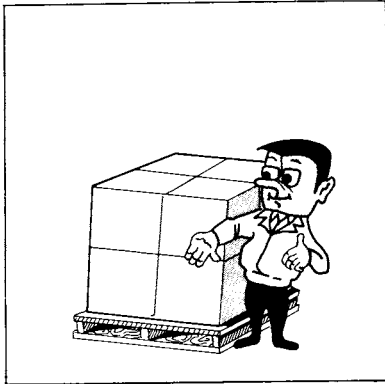

13094

21. Thoroughly inspect all loads to be moved for overload and/or poor balance. If the stability of a load is questionable, don't move it.

22. Unstable loads are a hazard to you and to your fellow workers. Always make certain that your load is well stacked and evenly positioned across both forks. Never attempt to lift a load with only one fork.

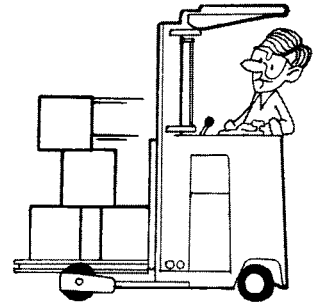

14947

14648



23. Before lifting, check to insure adequate unobstructed overhead clearance.

Gradually and smoothly pull up on lift/lower control arm. Smoothly return lever to neutral position to stop lift at desired level.

24. Push down on lift/lower control arm to lower load.

Descent of load may be stopped at desired level by smoothly returning lever to its neutral position.



14649

Safety

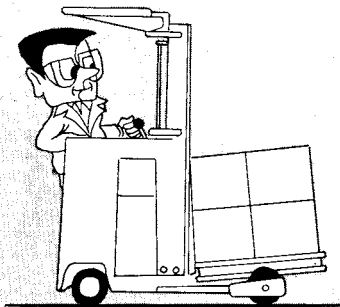

25. Always travel with load near floor (carriage should be tilted back to cradle load if truck has been optionally equipped with tilt).

Never lift or lower load while truck is in motion.

14948

14950

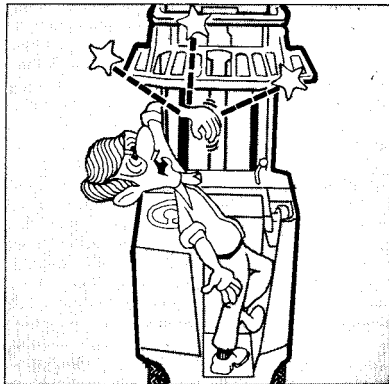

27. Never reach around or over windshield to place hands or fingers on upright. Stay in proper operator's position and keep hands, arms, feet and legs within the confines of the operator's compartment.

26. Never permit anyone to stand or walk under elevated forks or other load engaging attachments.

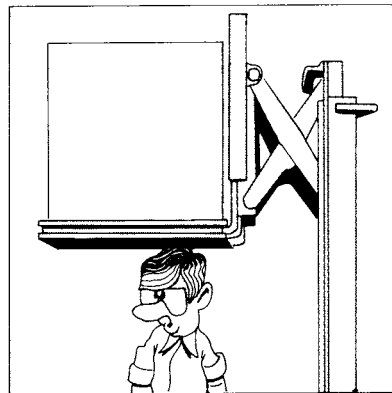

14949

13103

28. Slow down for turns, ramps, bumps, cross aisles, wet or slippery floors and at all times when visibility is restricted.

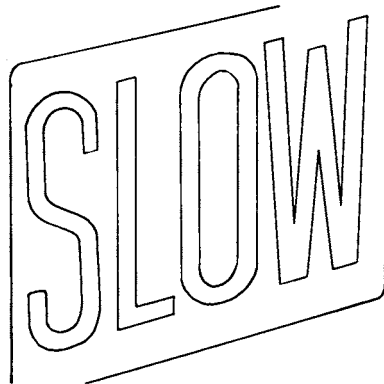

Safety

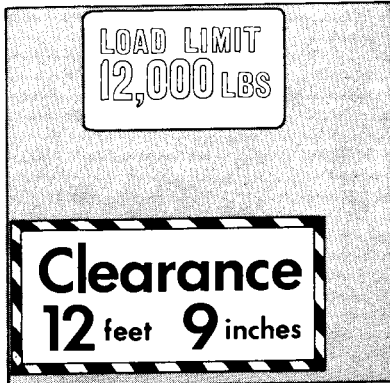

13102

13105

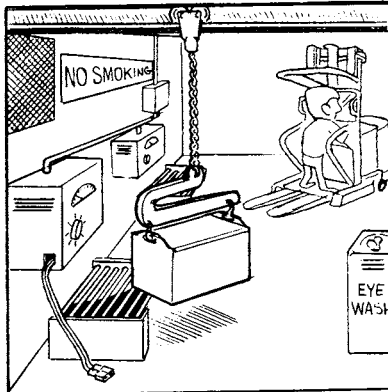

Code: OI-374 APR 75

29. Know and observe floor load limits and overhead clearances in all operating areas. Make certain that floors of boxcars, trucks, trailers and elevators are adequate before entering.

30. Use caution when placing loads or traveling near water pipes, overhead sprinklers, electrical wiring, steam pipes, heaters or other fragile or dangerous equipment or material.

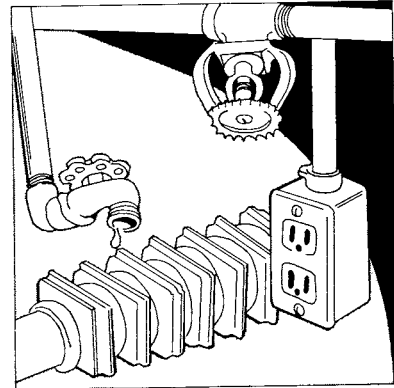

13104

13107

31. Batteries should be serviced or recharged only in designated charging areas and only by personnel thoroughly trained in safe battery servicing practices.

32. Never smoke or allow anyone to smoke in areas where batteries are being charged or in areas where fuels or other flammable fluids or materials are used or stored.

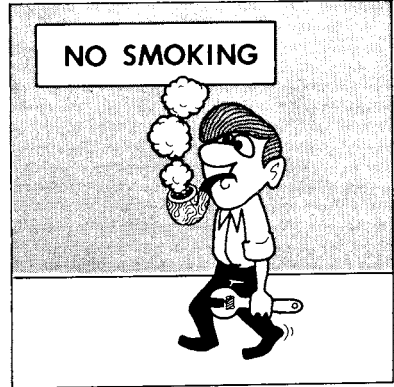

Safety



14951

33. Park lift trucks in designated areas only. Lower forks to floor (tilt carriage forward to place fork tips on floor if truck has been optionally equipped with tilt).

Place directional control in neutral, remove switch key and block drive wheels to prevent accidental roll.

14646



35. When handling bulky loads which, because of their size and shape, restrict your vision - operate your truck in reverse to improve visibility.

34. If truck is to be left unattended make certain that traffic aisles are unobstructed and leave truck as described in item 33.



14650

14952

36. Overhead guards and load backrest extensions are for your protection. Make certain that they are securely mounted and undamaged before operating your truck.

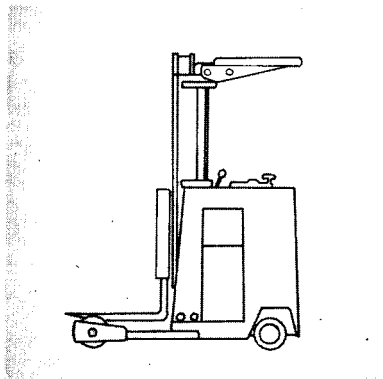

Safety

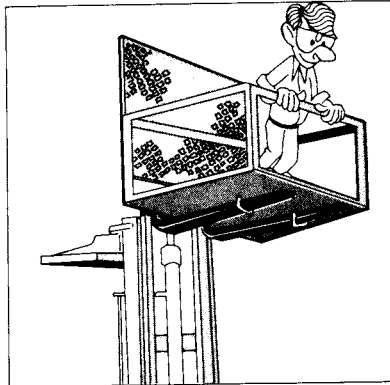

14966

14942

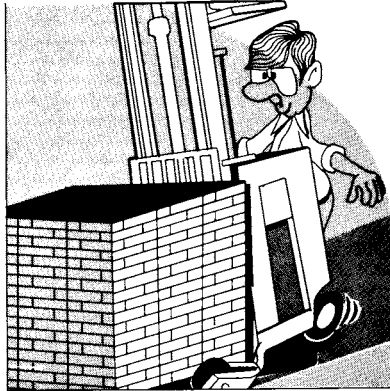

Code: OI-374 APR 75

37. Lift trucks are not designed as personnel elevators. If your truck must be used this way always use a properly designed safety platform securely attached to the forks and fork carriage.

39. Overloading is extremely dangerous. You don't have complete control of your truck and you are causing unnecessary wear.

If you are in doubt about the load weight being within the rated capacity range of your truck - don't move it, break it down.

38. Don't handle double tiered loads. They are unstable, difficult to control and dangerous. Even an overhead guard can't fully protect you from heavy objects falling from these heights.

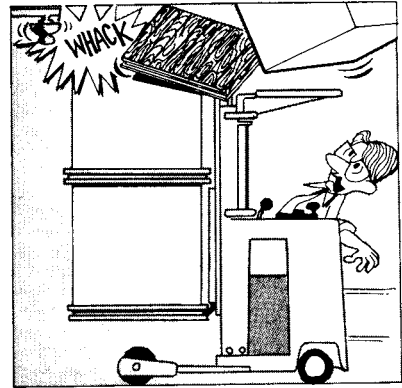

14953

14943

40. Don't pass other trucks traveling in the same direction at intersections, blind spots or other dangerous locations.

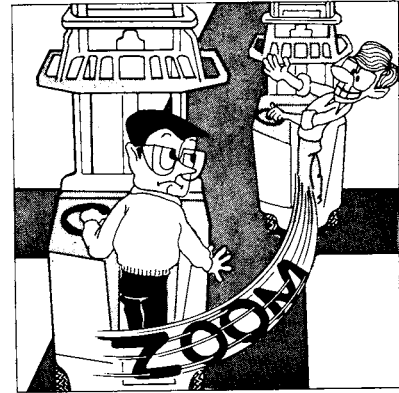

Safety

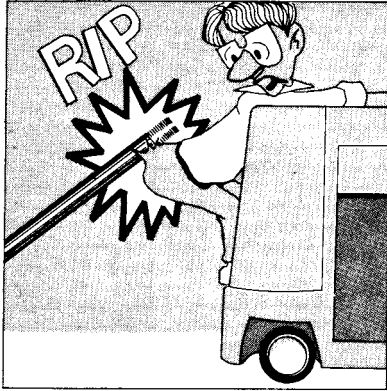

14945

41. Be especially careful when traveling in reverse and turning. Maneuvering in tight quarters can be a pain. Always keep your body within the running lines of the truck.

42. Never operate pantograph while traveling with load. Even well stacked loads can be unstable under this condition. Do not drive with pantograph extended.

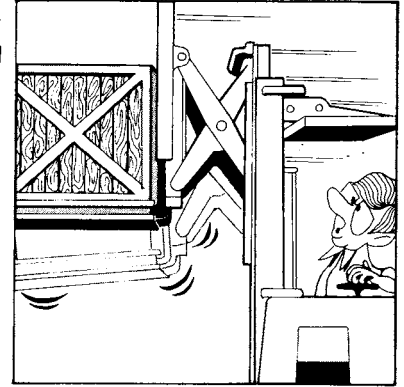

14954

14955

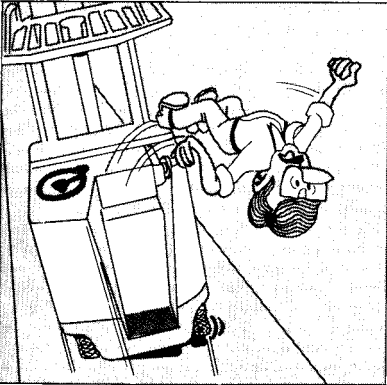

43. Always brake to a full stop before reversing direction of travel. Your truck can reverse quickly, you can't.

44. It can be risky to drive down a ramp load first. Your load can tip forward if the ramp is steep enough. Always back down a ramp to cradle the load when there is a danger of tipping the load. Never turn sideways on an incline.

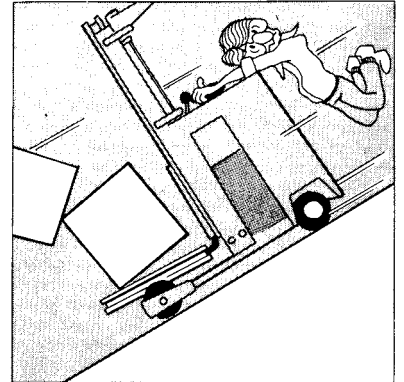

14956

Safety

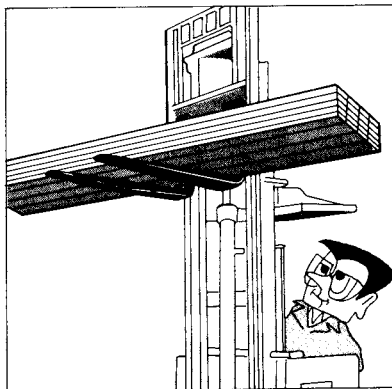

14944

45. Be extremely careful of load end swing when operating with loads of long lumber, pipe, etc.

Always carry load close to floor (tilt carriage back to cradle load if your truck has been optionally equipped with tilt) whenever possible.

14666



47. Follow a scheduled planned maintenance and lubrication program.

All adjustments and repairs must be performed by thoroughly trained and authorized personnel only.

46. Know the UL construction type of your truck and make certain that trucks of this type may be operated in restricted areas before entering. Never take an unauthorized truck into restricted or hazardous areas. Refer to item 20 on page 8 for location of UL construction type.

48. Remember - your safety and the safety of others depends on you. Keep your mind on operating your lift truck.

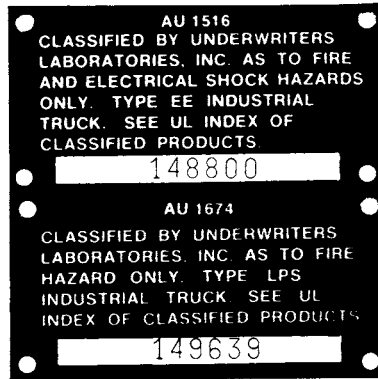

13178

14664

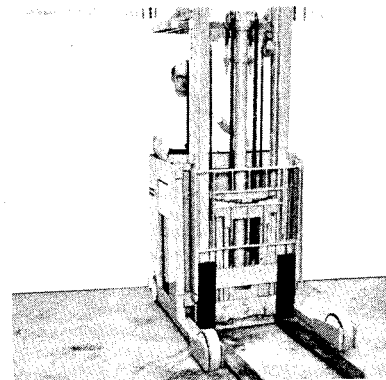

Operator's Compartment & Controls

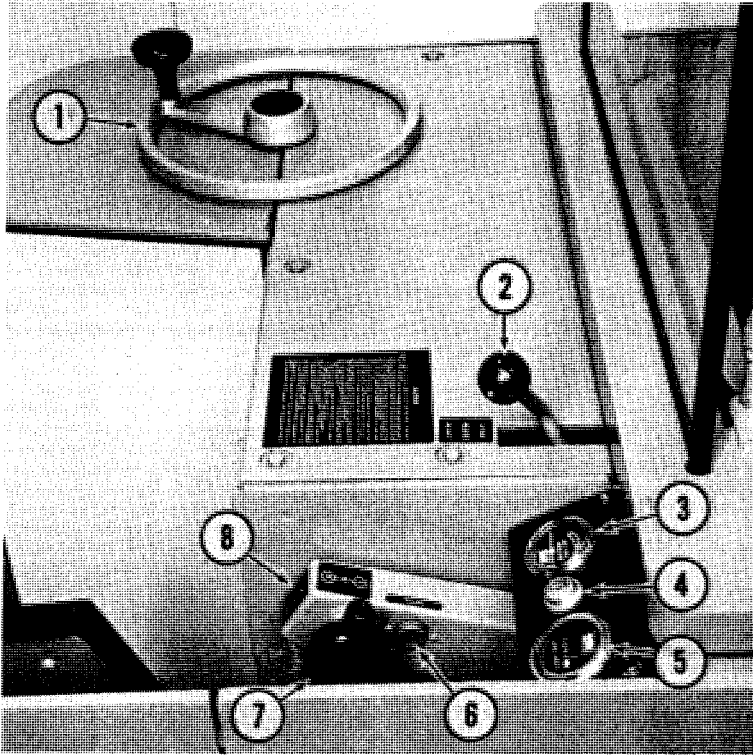

14667

1. Steering Handwheel. (Differs slightly on NP & NS300).
2. Reach Control Lever. NP models only. (Additional optional hydraulic control levers, if any, will be positioned to the left of this lever).
3. Battery Charge Indicator.
4. Key Switch.
5. Hour Meter.
6. Horn Button.
7. Forward/Reverse and Speed Control.
8. Lift/Lower Control Arm.

Before Operation

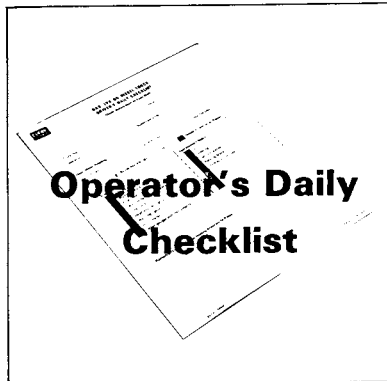

15197

1. Each shift operator must complete an operator's daily check list (available from your Clark Dealer).

2. Walk around truck and visually check for damage and leaks. Note all damage and leaks on check list.

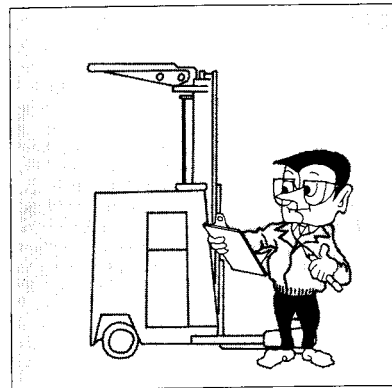

14957

14651

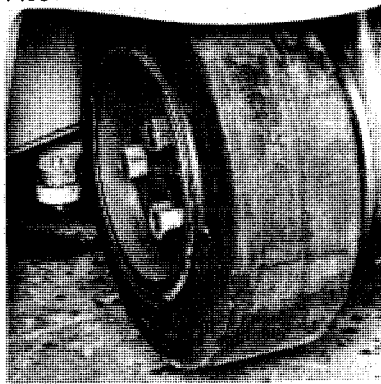

3. Check condition of drive/steer wheel and tire.

Note any apparent drive/steer wheel or tire damage on the check list.

4. NP500 model trucks are equipped with a steer idler wheel and tire connected to the drive/steer wheel and tire thru linkage.

Check condition of idler steer wheel and tire.

Note any apparent idler steer wheel or tire damage on the check list.

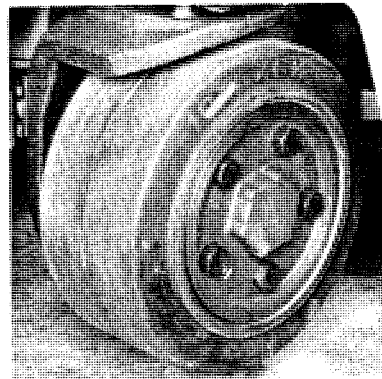

14652

Before Operation

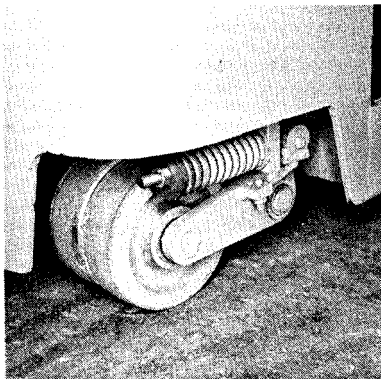

16789

5. NS & NP300 models are equipped with a spring loaded swivel caster wheel and tire rather than an idler steer wheel and tire.

Visually check the condition of the caster wheel, tire and springs and note it on your check list.

16790

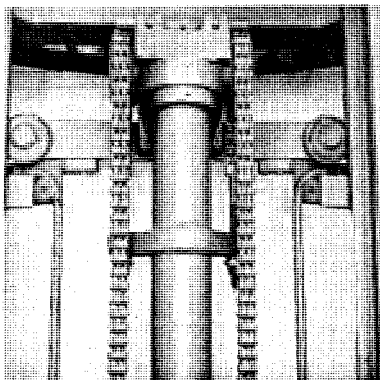

7. Visually check condition of lift chains, hoses, sheaves and retainers. Note condition of these items on your check list.

6. Check battery retainers to make certain they are undamaged and properly positioned.



14653

8. Standard NP models are equipped with one large load wheel and tire at the end of each outrigger.

Check condition of load wheels and tires.

Note any apparent load wheel or tire damage on the check list.

14655

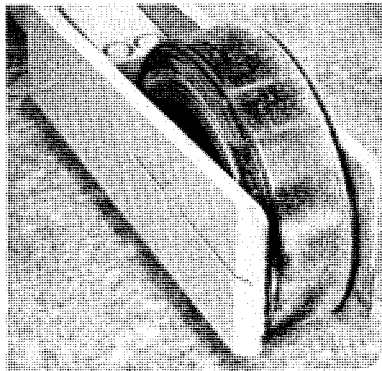

Before Operation

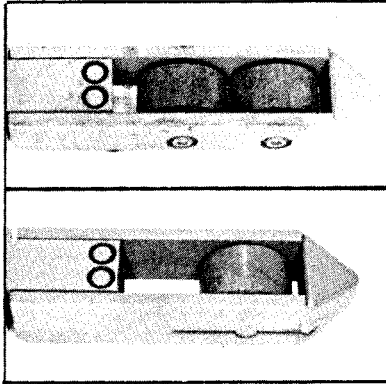

9. NS models are equipped with load rollers (normally two) at the end of each out-rigger.

Check the condition of these load rollers.

Note any apparent load roller or toe box damage on your check sheet.

13661

14668

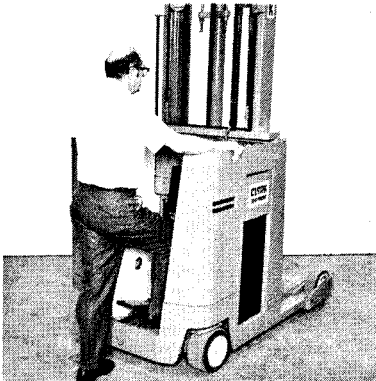

10. Check condition of overhead guard and load backrest extension.

Make certain that they are properly positioned and secured.

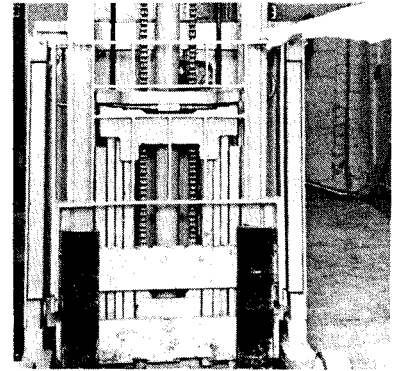

14656

14669

11. Remove blocks from drive wheel and carefully enter operator's compartment.

Use caution not to step on brake pedal when entering as this will release brake and cause truck to roll if parked on an incline.

12. Visually check battery connector to make certain that it has been properly connected and is undamaged.

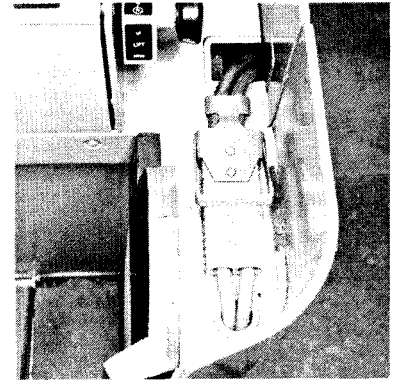

Before Operation

13. Insert key into switch and turn clockwise to the "on" position.

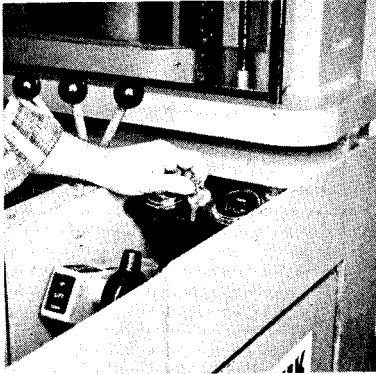

14650

14. Press horn button to insure that the horn is undamaged and functioning properly.

If horn does not function properly, report it immediately to the designated authority.

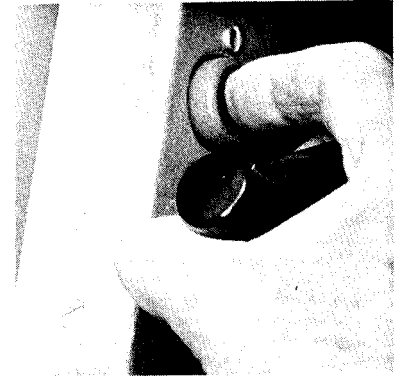

14647

13225

15. Check hour meter to insure that it is undamaged and functioning properly.

Report any malfunction or damage to the proper authority.

Record hour meter reading on your daily check list.



16. Check battery charge indicator for damage. Needle should remain in green area. Check this meter frequently during operation.

Report any damage or malfunction immediately.



13179

Before Operation

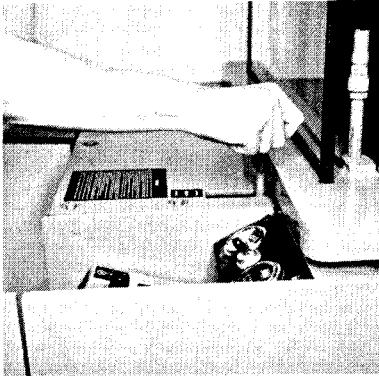

14672

17. On NP models only . . . Make certain that you have adequate unobstructed forward clearance. Push forward on the "reach" control lever and hold while observing forward extension of carriage and forks. When carriage is fully extended, check battery charge indicator and release lever. (Indicator needle will remain in green area if battery has sufficient charge), then . . .

Code: OI-374 APR 75



14673

18. On NP models only . . . Pull back on the reach control lever to return carriage and forks to their original position against the face of the upright and release the control lever.

Note any erratic or unusual carriage reach or retract operation on the check list.



14648

19. Check for adequate unobstructed overhead clearance. Gently pull up on lift control arm. Observe upright lift and report any erratic or unusual operation.

Smoothly return control arm to its neutral position to stop lift at desired point.

Before Operation

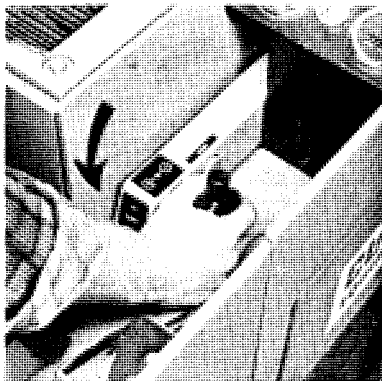

14649

20. Push lift control arm down and hold while observing descent of upright. When forks reach desired position, slightly above floor, smoothly return control arm to its neutral position to stop lowering of upright.

Report any erratic or unusual operation immediately.

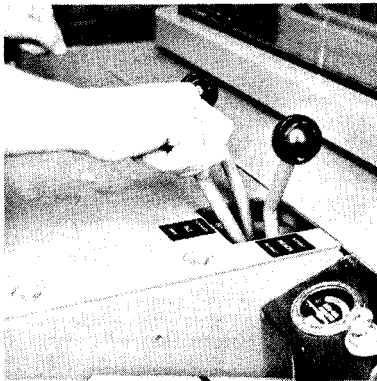

14670

21. If your truck has been optionally equipped with a tilting carriage you should check for proper operation.

Gently pull back on tilt control lever (NP lever is as shown — NS lever will be the only lever or lever at right) and hold until carriage reaches full back tilt. Then release control lever.

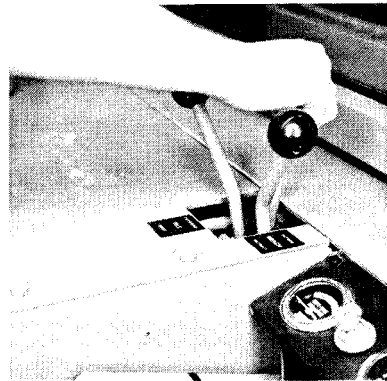

14671

22. Push forward on tilt control lever and hold until fork carriage tilts forward to near vertical position.

Release control lever to stop carriage tilting action at desired point.

Note any erratic forward and back tilt operation on your check list.

Before Operation

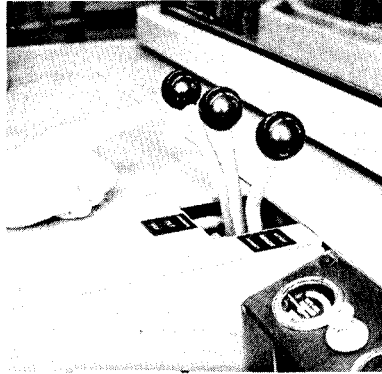

14674

23. If your truck has been optionally equipped with an auxiliary valve, this valve will be operated by the lever at the left of the "reach" or optional "tilt" lever on NP models. On NS models this lever will be alone or at the left of the optional tilt lever.

24. Now place your left foot on the brake pedal and push it down to floor board level.

This will release the brake and, at the same time, activate a switch which will complete the power circuit to the drive motor.

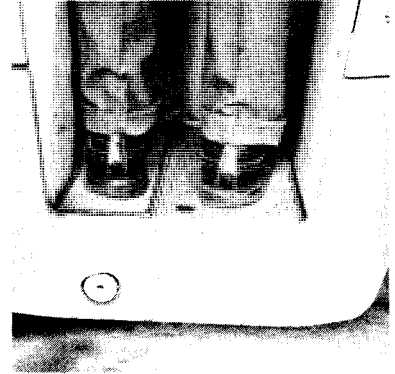

14675

14646

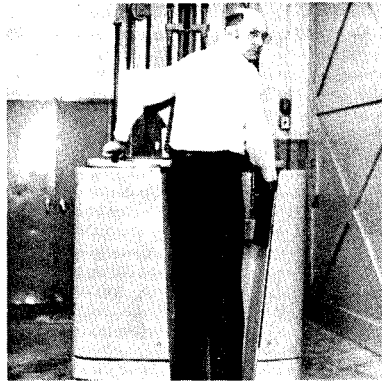

25. Check all around truck to insure that your desired path of travel is unobstructed.

26. Gently and smoothly turn the directional/speed control knob in the proper direction for desired path of travel (counterclockwise for reverse and clockwise for forward). Further rotation of directional/speed control knob in selected direction will increase truck speed to desired level.



14657

Before Operation

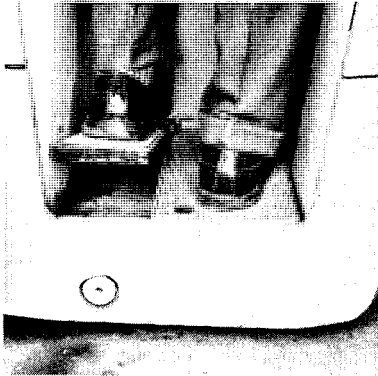

14676

27. When truck begins to move in selected direction (item 26), return directional/speed control knob to its neutral position and smoothly raise your foot from the brake pedal to apply brake and smoothly stop truck.

If brake does not operate properly do not operate truck.

14677

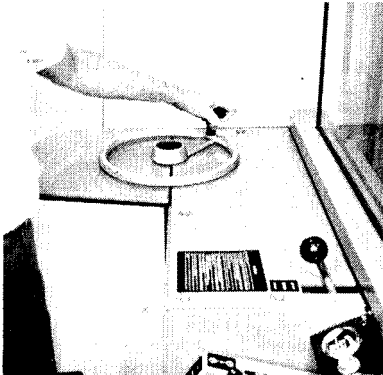

29. Stop truck as outlined in item 27 and check steering by rotating steer wheel to full left and full right turn.

28. When truck comes to complete stop rotate the directional/speed control knob in the direction opposite that chosen in item 26 (clockwise for forward and counterclockwise for reverse). Further rotation of control knob in the selected direction will increase truck speed to desired level.



14658

14649

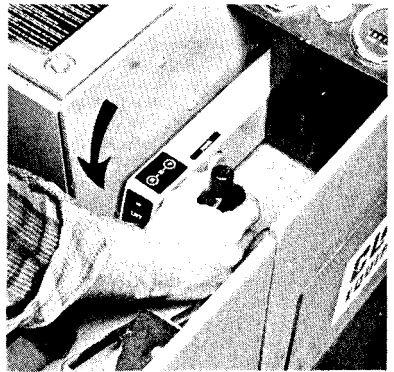

30. Push down on lift/lower control arm until forks reach the floor. Return control arm to neutral position to stop lowering of forks at desired level.

Before Operation

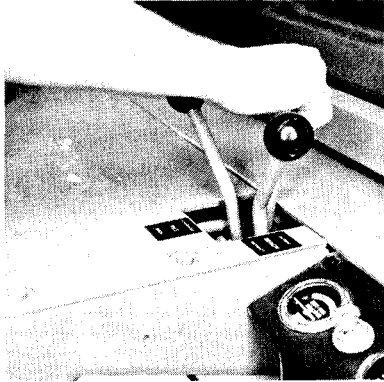

14671

31. If your truck is equipped with tilt - push forward on tilt control lever to lower fork tips to floor. Release tilt control lever and it will return to its neutral position.

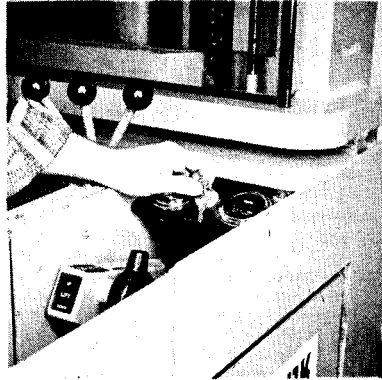

14650

32. Turn switch key counterclockwise to "off" position, remove key and carefully dismount from truck. Don't forget to block drive wheel to prevent accidental roll.

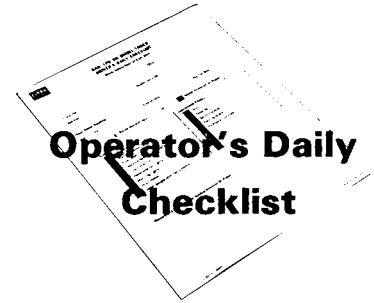

15197

33. Review operator's daily check list to make certain that it has been properly marked and turn it in to the designated authority.

Operation

1. Remove blocks from drive wheel and carefully enter operator's compartment.

Remember that pressing down on the brake pedal will release the brake and this should be avoided until ready to move the truck.

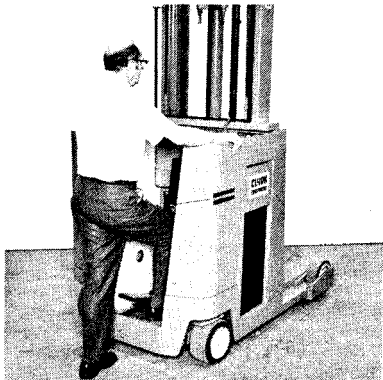

14668

2. Look at battery connector to make certain that it is properly plugged in. Insert the key into the switch and turn clockwise to the "on" position.

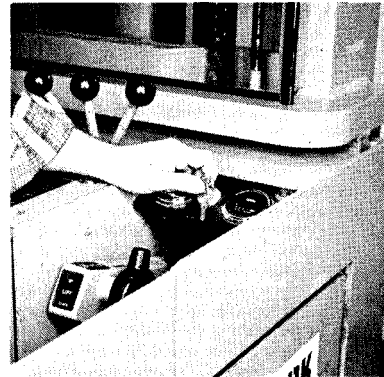

14650

3. Smoothly and gently pull back on "tilt" control lever (if your truck is so equipped) to raise fork tips from floor slightly.

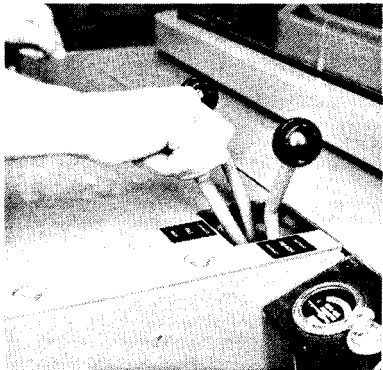

14670

4. Gently pull up on lift control arm to raise forks from floor slightly.



14648

Operation

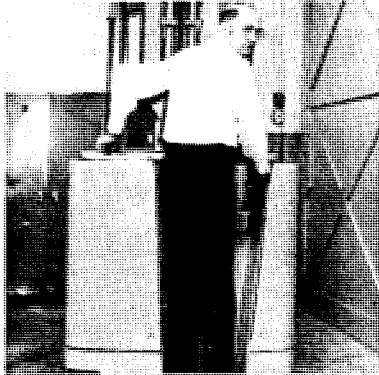

14646

5. Check all around truck to make sure that your desired path of travel is unobstructed.

6. Place your left foot on the brake pedal and push it to the floor board.

This will release the brake and activate a switch completing the power circuit to the drive motor.

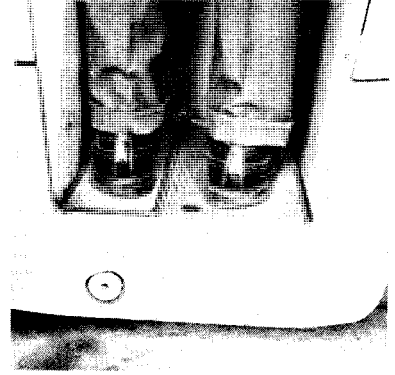

14675

14657

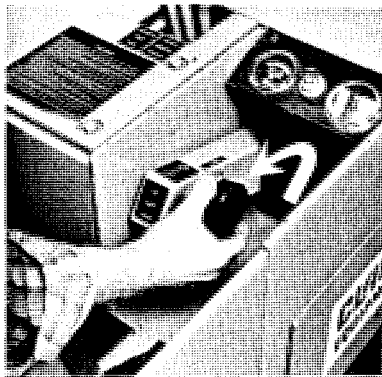

7. Turn the directional/speed control knob counterclockwise for reverse travel (clockwise for forward).

Further rotation of the directional/speed control knob will increase truck speed to the desired level.

8. Remember to come to a complete stop before changing direction of travel. This is accomplished by returning the directional/speed control knob to its neutral position and smoothly releasing the brake pedal.

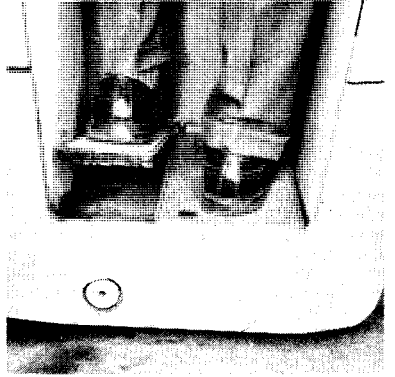

14676

Operation

9. Always be alert for pedestrians, other trucks or obstacles in your path of travel.

10. Remember to enter load slowly and squarely.

Load should be centered and forks should be near outside edges, if they are not —

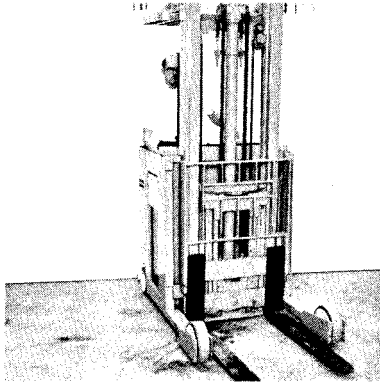

14664

10758

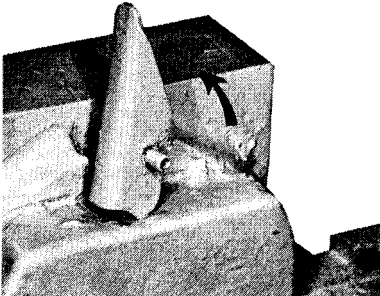

11. — Adjust them by lifting fork lock lever and sliding forks to the desired position. Then...

12. ... Remember to lower lever to lock forks securely into notch atop fork bar.

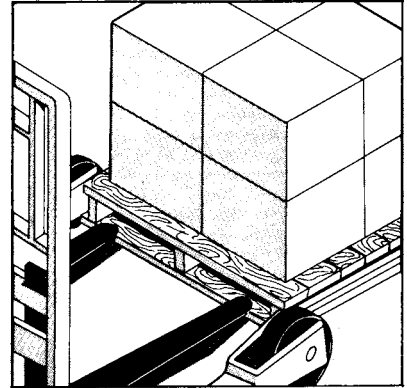

14967

10759

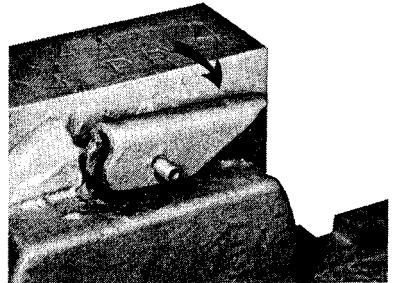

Operation



14648

13. Always remember to check for unobstructed overhead clearance before lifting load. When you are certain that clearance is adequate, gently and smoothly pull up on lift control arm. Smoothly return lift control lever to neutral to stop lift at desired level.

14. Remember that load should be lowered to position near floor (if your truck has been optionally equipped with tilt - the carriage should be tilted back to cradle the load) when traveling.

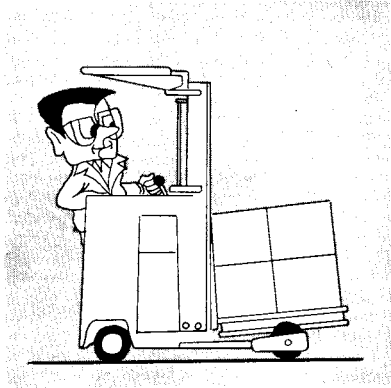

14948

14968

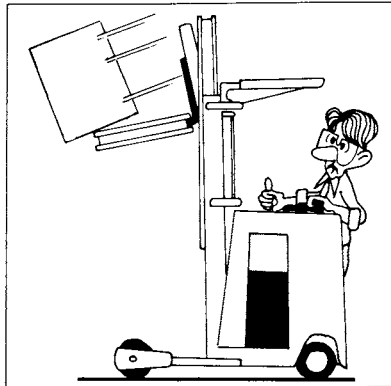

15. Use minimum forward and reverse tilt when stacking and unstacking loads.

Never tilt load forward unless it is over stack or at low lift height.

16. Be constantly alert for unusual or erratic operation.

Report any malfunction immediately so that adjustments or repairs may be made by thoroughly trained and qualified personnel.

14666

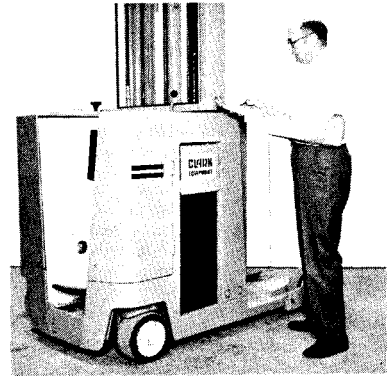

Parking

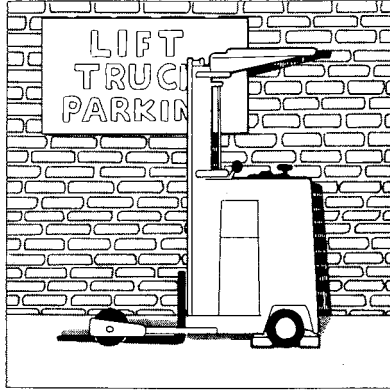

14951

14671

1. Park lift trucks in designated parking areas only.

Do not obstruct traffic lanes or aisles.

2. Lower forks to floor.

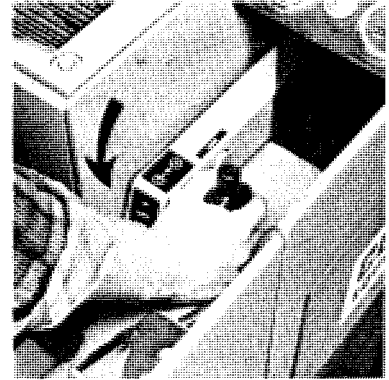

14649

14650

3. If your truck has tilt - push forward on tilt control lever to place fork tips on floor.

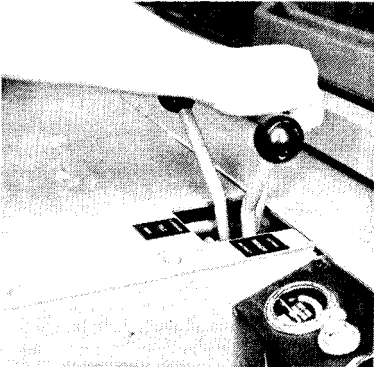

4. Turn key switch counterclockwise to "off" position and remove the key.



Parking

5. Carefully dismount from truck.

6. Remember to block drive wheel securely to prevent accidental roll.



14668

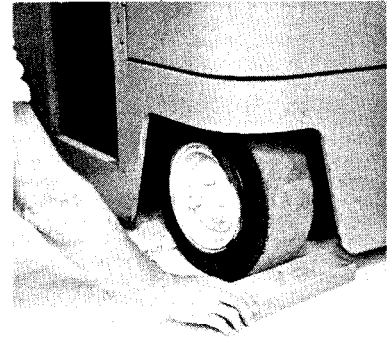

14940

Notes

For Handy Reference

RECORD THE FOLLOWING INFORMATION PERTAINING TO YOUR TRUCK

Model No.

Serial No.

Attachments

Truck Weight W/Battery

Truck Rated Capacity

Gross Truck Weight (W/Battery and Rated Load)

Customer Truck Identification No.



Additional copies of this manual may be purchased from:

YOUR AUTHORIZED CLARK
DEALER