Operator's Instruction Manual



PW 15/18

CLARK

Book No. OI-525, 1st REV.



WARNING

**FOR YOUR SAFETY AND THE
SAFETY OF OTHERS**

BEFORE YOU OPERATE THIS TRUCK!

**READ ALL WARNINGS AND INSTRUCTIONS IN THE
OPERATOR'S MANUAL AND ON THE TRUCK.**

CHECK THE TRUCK FOR CORRECT OPERATION.

**DO NOT OPERATE THIS TRUCK UNLESS YOU ARE
TRAINED AND AUTHORIZED TO DO SO.**

FOREWORD

Federal and state laws require that operators be completely trained in the safe operation of lift trucks.

Before you start operating this lift truck, make sure that you understand all driving procedures. It is important to operate your lift truck safely and efficiently.

This manual will help you learn how to operate your lift truck. This manual describes the controls, special features and the functions of each control.

This manual is not a training manual, it is a guide to help authorized operators safely operate a lift truck. Illustrations in this manual show the operator correct procedures for checking, starting, operating and stopping the lift truck.

Clark lift trucks are built to take hard work, but not abuse. They are built to be dependable but as with any lift truck, they are only as efficient as the operator and the persons responsible for maintaining them.

Do not make any repairs to this lift truck unless you have been trained in lift truck repair procedures and authorized by your employer.

MANUALES DE INSTRUCCIÓN PARA OPERADORES IMPRIMIDOS EN ESPAÑOL SON OBTENIDOS DE SU DISTRIBUIDOR CLARK.

BETRIEBSANWEISUNGEN IN DEUTSCHER SPRACHE KOENNEN SIE BEI IHREM CLARK-HAENDLER ERHÄLTEN.

MANUELS DE L'OPERATEUR EN LANGUE FRANCAISE PEUVENT ETRE COMMANDES CHEZ VOTRE DISTRIBUTEUR CLARK.

TABLE OF CONTENTS

Operator's Warning	Page 0
Foreword	Page 1
Drive Safely	Page 3
ITA Recommended Practices	Page 4
Know Your Truck	Page 5
Decals and Plates	Pages 6-9
Safety	Pages 10-19
Operator Controls	Page 20
Before Operation Checks	Pages 21-26
Operation	Pages 27-32
Parking	Pages 33-34
Charging Instructions	Pages 35-38

DRIVE SAFELY

BEFORE YOU OPERATE THIS LIFT TRUCK, READ AND UNDERSTAND THE INSTRUCTIONS, SIGNS AND MESSAGES IN THIS MANUAL AND ON THE LIFT TRUCK.

INJURY OR DEATH TO YOU OR OTHER PERSONNEL WILL OCCUR IF YOU DO NOT FOLLOW THESE INSTRUCTIONS AND MESSAGES.

STAY ALERT!

SUMMARY OF SAFE OPERATING PROCEDURES

1. Do not operate this truck unless you have been trained and authorized to do so. Read all warnings and instructions in operator's manual and on this truck.

2. Do not operate this truck until you have checked its condition. Give special attention to Tires, Horn, Lights, Battery, Controller, and Lift Systems including forks, limit switches, brakes, steering mechanism, and guards.

3. Do not ride on this truck. Operate only when standing on the floor.

4. Do not handle loads which are higher than the load backrest unless load is secured so that no part of it could fall backward.

5. Do not handle unstable or loosely stacked loads. Use special care when handling long, high or wide loads to avoid losing the load, striking bystanders, or tipping the truck.

6. Do not overload truck. Check capacity plate for load weight information.

7. Start, stop, travel, steer and brake smoothly. Slow down

for turns and on uneven or slippery surfaces that could cause truck to slide or overturn. Operate carefully when traveling without a load as the risk of overturn is greater.

8. Travel with load or lifting mechanism fully raised. Look in the direction of travel and operate the truck so that the load does not interfere with your view.

9. Operate carefully on ramps, travel slowly and do not angle or turn. Always operate on ramps with load end downhill.

10. Observe applicable traffic regulations. Yield right-of-way to pedestrians. Slow down and sound horn at cross aisles and wherever vision is obstructed.

11. Before lifting, be sure load is centered and forks are completely under load.

12. Do not put any part of your body under the forks or load.

13. Do not lift or travel with personnel on the forks.

14. Before leaving the truck, make sure the control handle is fully raised and the lifting mechanism is lowered.

KNOW YOUR TRUCK

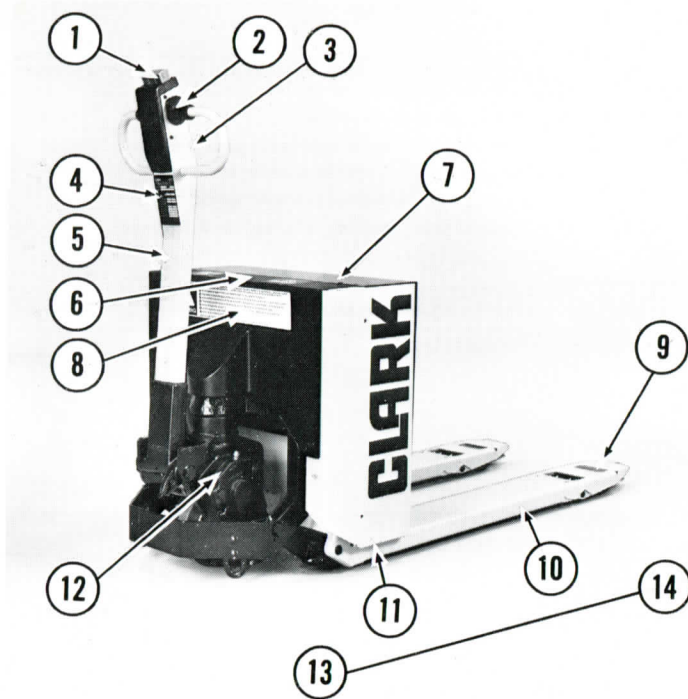

1. Mechanical Reversing Switch
2. Directional and Speed Control
3. Horn, Lift, and Lower Buttons
4. Capacity Plate
5. Control Handle
6. Operator's Decal, No Riding Decals
7. Battery Cover
8. Warning Decal
9. Load Wheels
10. Pallet Forks
11. Serial Number Location
12. Drive Unit
13. Front of Truck
14. Rear of Truck

PW 15, PW 18
Capacities: (1500 kg., 1800 kg)
3300 lb., 4000 lb.

OPERATOR WARNING DECAL



DO NOT OPERATE THIS MOTORIZED HAND TRUCK UNLESS YOU ARE TRAINED AND AUTHORIZED. READ AND UNDERSTAND ALL WARNINGS AND INSTRUCTIONS IN THE OPERATOR'S MANUAL AND ON TRUCK BEFORE STARTING.

- 1 Do not operate damaged or faulty truck. Report damage or faulty operation immediately.
- 2 Keep hands on designated grips and feet away from truck. Do not operate truck with wet or greasy hands or shoes.
- 3 Enter confined areas with load end first. Be very careful when operating in confined areas to avoid being pinned.
- 4 Travel slowly and with caution on slopes and do not turn. Always travel with load end down grade.
- 5 Do not overload truck. Do not handle shakey loads. Be very careful when handling long, high or wide loads.
- 6 Do not exceed floor weight limits.
- 7 Avoid uneven or slippery surfaces and loose materials.

BREAKING ANY OF THESE RULES MAY CAUSE SERIOUS INJURY TO YOURSELF AND OTHERS

23720

The operator's warning decal, located on the front cover, describes basic instructions for safe operation of a lift truck. Read and understand these instructions plus the other messages in this manual and on the lift truck.

OPERATOR'S DECAL

The operator's decal, located on the front cover, shows the operator the function of the buttons on the control handle.

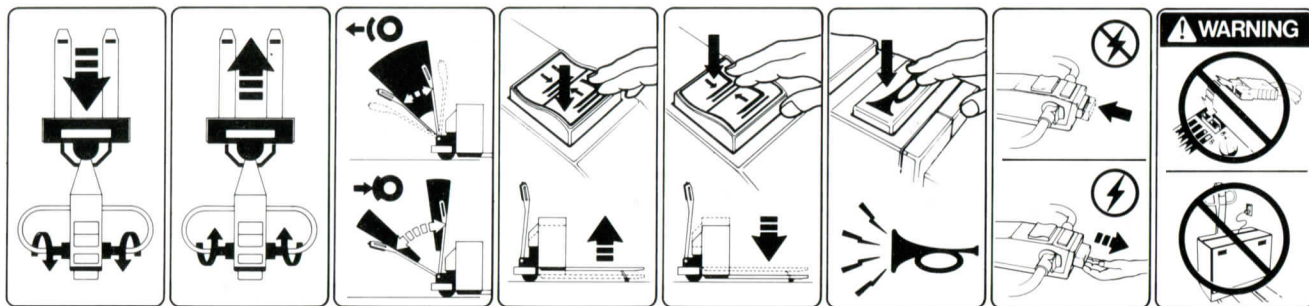

23784

NO RIDING DECAL



23735

U. L. PLATE

AU 1393
CLASSIFIED BY UNDERWRITERS'
LABORATORIES, INC. AS TO FIRE
AND ELECTRICAL SHOCK HAZARDS
ONLY. TYPE E INDUSTRIAL
TRUCK. SEE UL INDEX OF
CLASSIFIED PRODUCTS.

22271

The 'No Riding' decal and Underwriters' Laboratories (U.L.) plate are located on the front cover.

TRUCK DATA AND CAPACITY PLATE

CLARK	Industrial Truck Division
TRADEMARK OF CLARK EQUIPMENT COMPANY U.S.A. MANUFACTURED UNDER LICENSE BY CLARK MAQUINARIA S.A. IN ZARAGOZA, SPAIN.	
MODEL NO. <input type="text"/>	TYPE <input type="text"/>
SERIAL NO. <input type="text"/>	
	LBS KGS
CAPACITY <input type="text"/>	<input type="text"/>
TRUCK WEIGHT:	
WITHOUT BATTERY <input type="text"/>	<input type="text"/>
WITH MAX. BATTERY <input type="text"/>	<input type="text"/>
BATTERY WEIGHT:	
MAXIMUM <input type="text"/>	<input type="text"/>
MINIMUM <input type="text"/>	<input type="text"/>
BATTERY TYPE <input type="text"/>	<input type="text"/>
D.C. VOLTAGE <input type="text"/>	<input type="text"/>
MAX. AMP HOURS <input type="text"/>	<input type="text"/>
FROM FACTORY THIS TRUCK MEETS PART II, ANSI B-56.1, 1969 1975.	
PART NO. 2377029	

Know the rated capacity of your lift truck. Never exceed this rated capacity.

Read the rated capacity on the data plate, and read and know areas 1 through 11 as shown in the illustration.

1. Truck Model
2. Type
3. Serial Number
4. Capacity
5. Truck Weight Without Battery
6. Truck Weight With Maximum Weight Battery
7. Battery Weight — Maximum
8. Battery Weight — Minimum
9. Battery Type
10. Voltage
11. Maximum Amp Hours

SAFETY

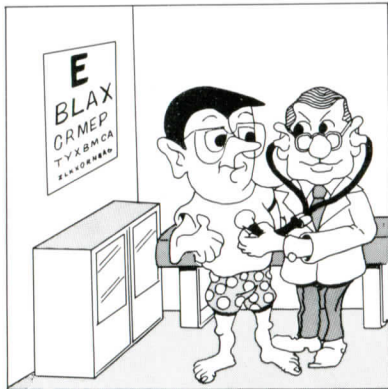

13696

Only trained and authorized personnel can operate Clark lift trucks.

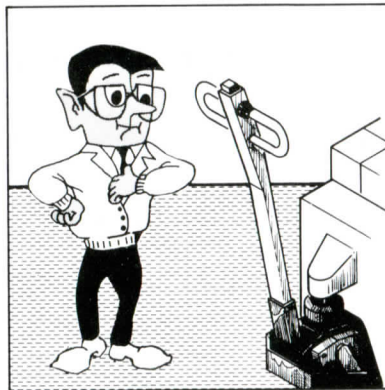

23765

Wear safety glasses and safety shoes when operating a lift truck. Do not wear loose clothing.

ELECTRIC TRUCK DRIVER'S DAILY CHECKLIST

Check Before Start Of Each Shift

Date _____

Truck No. _____ Supervisor's OK _____

Operator _____

Hour Meter Reading _____ End of Day _____ Hrs. for Day _____

Start of Day _____

Boxes Accordingly OK Needs Attention or Repair

Visual Checks:	Operational Checks:
<input type="checkbox"/> Obvious damage and leaks	<input type="checkbox"/> Horn
<input type="checkbox"/> Tire condition	<input type="checkbox"/> Steering
<input type="checkbox"/> Battery plug connection	<input type="checkbox"/> Service brakes
Note: Be sure the battery plug connection is tight.	<input type="checkbox"/> Battery Load Test
<input type="checkbox"/> Head and tail lights	Note: Watch battery indicator while holding till lever on full back tilt. If needle falls to red area, battery doesn't have sufficient charge to operate truck properly.
<input type="checkbox"/> Warning lights	<input type="checkbox"/> Parking brake
<input type="checkbox"/> Hour meter	<input type="checkbox"/> Seat brake
<input type="checkbox"/> Other gauges and instruments	<input type="checkbox"/> Hydraulic controls
<input type="checkbox"/> Battery Discharge indicator	
Note: Key on, needle should indicate in green area.	

13124

Inspect your truck with the operator's daily checklist before you operate it. Make sure all safety systems work correctly. Do not operate a lift truck that has damage or is not safe. Make a report of decals that are missing or damaged and replace them immediately.

SAFETY

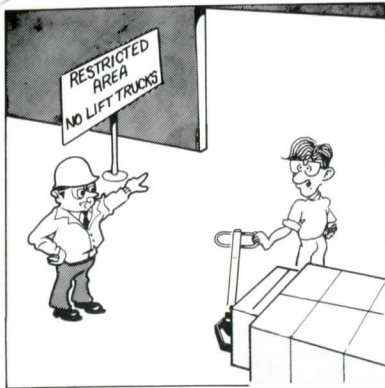

23778

Do not operate your truck in unauthorized areas. Follow all safety rules and read all warning signs. Slow the speed of your truck and use the horn near corners, exits, entrances, and near people.

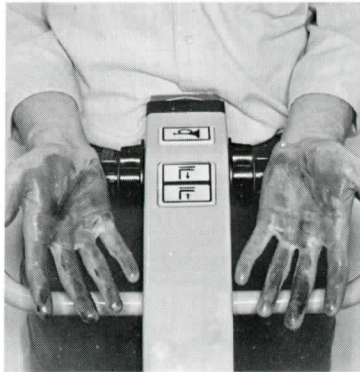

23350

Never operate a lift truck with wet hands or shoes. Never hold any controls with grease on your hands. Your hands will slide off of the controls and cause an accident.

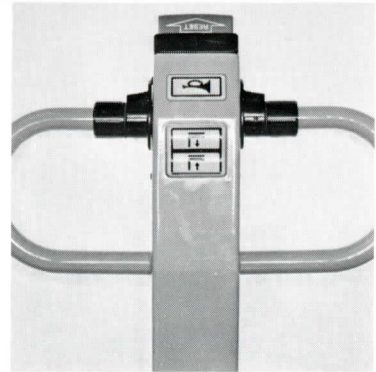

23351

Before operating your truck, check steering, horn, brake application, forward-reverse switch, lift-lower controls and mechanical reversing switch for correct operation.

SAFETY



23352

Look all around truck before moving it in any direction. Remember to start and stop slowly and smoothly.

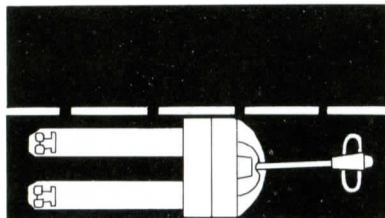
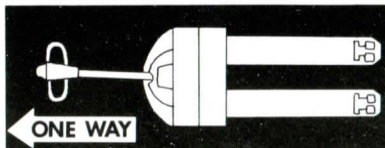

14686

Operate truck only in truck routes and keep operating aisles clean.

One-way aisles are recommended. If this does not fit your operation, keep to the right of the center line.

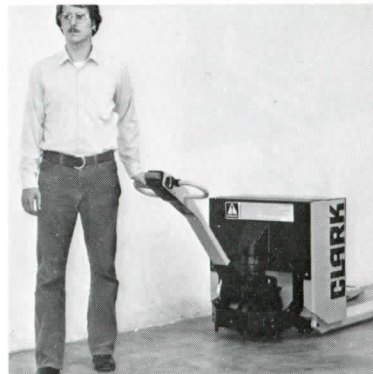

23353

Always look for pedestrians, other trucks or obstructions in your path of travel.

SAFETY

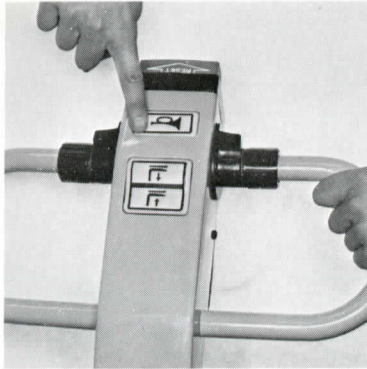

23354

When operating your truck in reverse, remember to press the horn at all corners, exits, entrances and when nearing pedestrians.

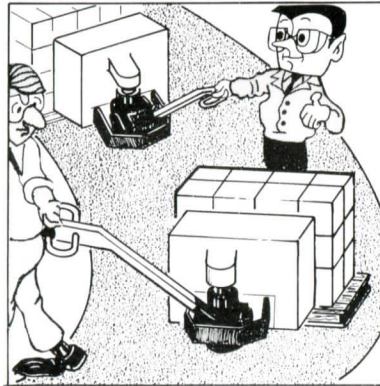

23766

Keep a safe distance from the truck ahead of you at all times. Make sure there is enough distance to permit you to stop smoothly and safely.

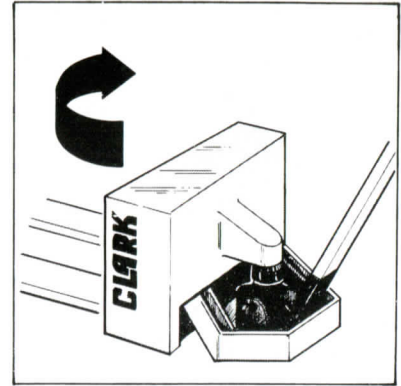

23767

Be careful of drive end travel when turning while operating the truck in reverse direction. Damage to material or equipment in your operating area and/or to the drive end of your truck may result.

SAFETY

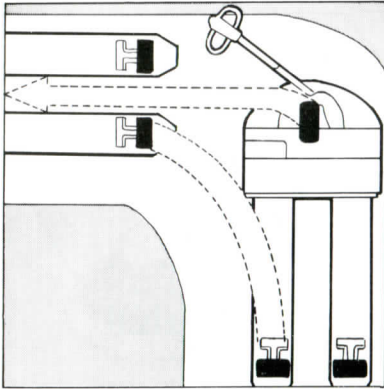

23768

Use caution when making right or left turn into aisle. Remember that load wheels do not follow the turn path of the drive wheel.

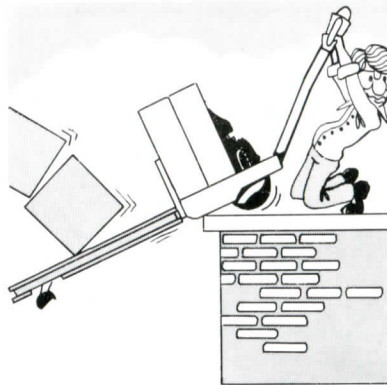

23769

Be careful when operating a lift truck near the edge of a loading dock or ramp. The truck can fall over the edge and cause injury or death. Keep a safe distance from the edge and use caution when the floor is slippery.

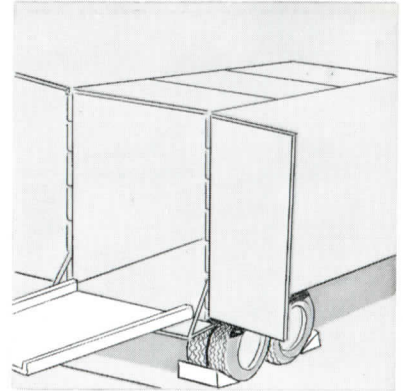

13146

Do not operate over bridge plates unless they are strong and can support the weight of the truck and load. Make sure they are in the correct position. Put blocks on the vehicle you enter to keep it from rolling. Be careful, a lift truck can fall and cause injury or death.

SAFETY

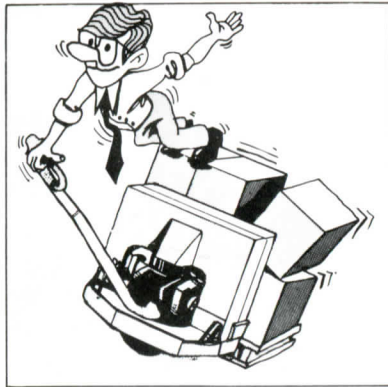

23771

Trucks of this type are made to be controlled by a walking operator. Never ride a truck of this type.

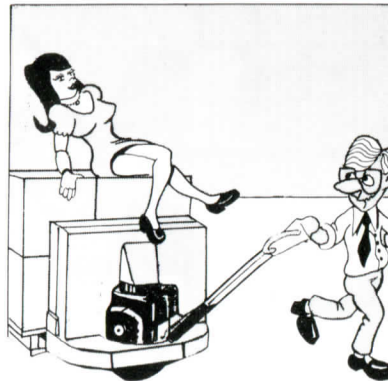

23772

Do not let other personnel ride on the truck. They can fall off or cause you to have an accident. Lift trucks are designed to carry loads, not personnel.

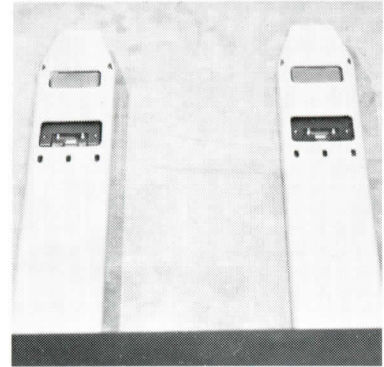

23355

Know the position of your fork tips at all times when truck is in motion in reverse. Do not permit the fork tips to hit anything.

SAFETY

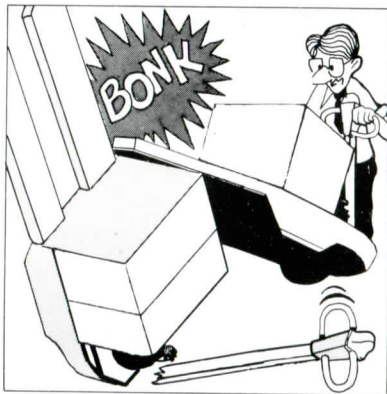

23770

Do not use your lift truck to push or tow another truck. Do not let another push or tow your truck. If a truck will not move, call a service technician.

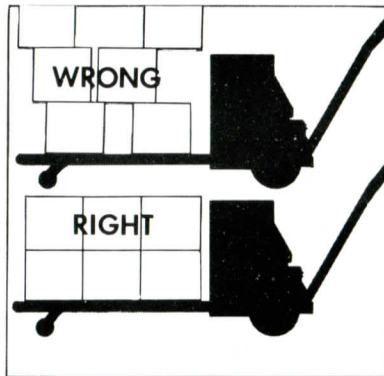

23773

Do not lift or move a load unless both forks are fully under the load. Do not lift a load with one fork. Handle loads carefully and check them closely for stability and balance. Remember, loose loads can fall and cause injury and damage.

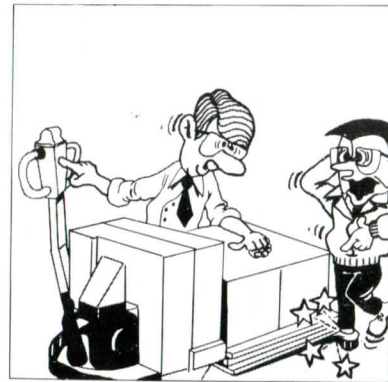

23774

Never permit anyone to stand in an area where the load is to be put. Make sure the area where the load is to be put is clean.

SAFETY

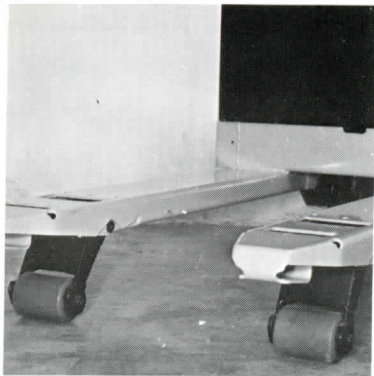

23692

Always travel with load forks in full "up" position.

Never raise or lower load forks while truck is moving.



14681

Know the floor load limits in all operating areas.

Never enter an elevator, a box-car, a semi-trailer or any other area until you are sure the floor is strong enough to hold you, your truck, and the load.

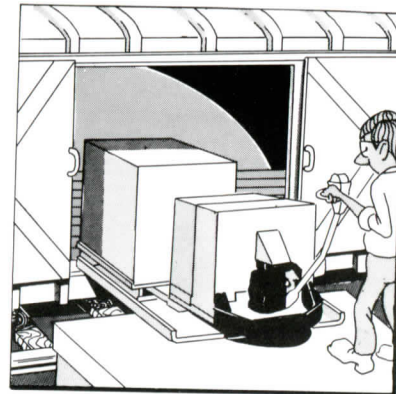

23776

Areas such as elevators, semi-trailers, trucks or boxcars must be entered in reverse (trail frame first) to make it easier to leave them.

SAFETY

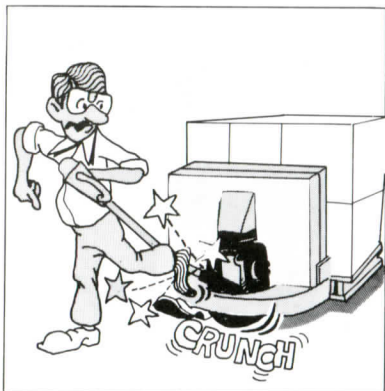

23777

... Remember to keep your feet away from the front of the truck when operating it.

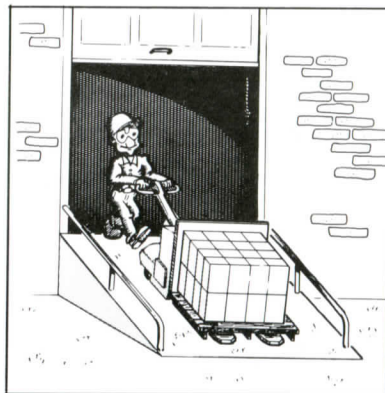

21499

When moving up or down a grade, the forks should be kept downgrade with or without a load on the truck.

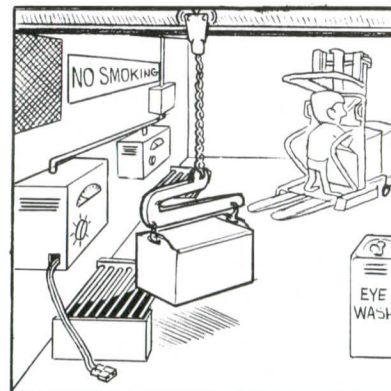

13105

Batteries should be serviced or charged only in charging areas and only by personnel trained in safe battery maintenance.

SAFETY

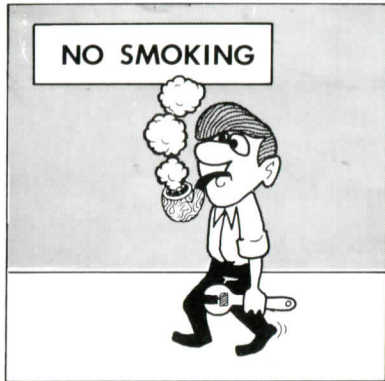

13107

Never smoke or permit anyone to smoke in areas where batteries are being charged or in areas where fuel or other flammable fluids or materials are kept or used.

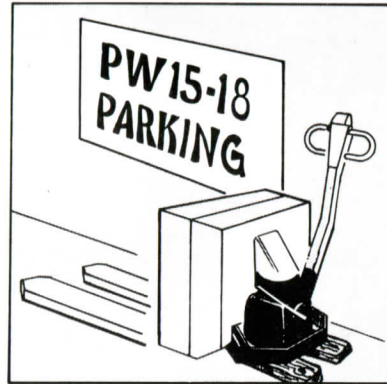

23775

Park your lift truck in authorized areas only. Fully lower the forks to the floor and make sure the control handle is in the 'up' position to apply the brakes. Put blocks at the drive wheel to prevent the truck from rolling. Remove the battery cover and disconnect the battery.

OPERATOR CONTROLS

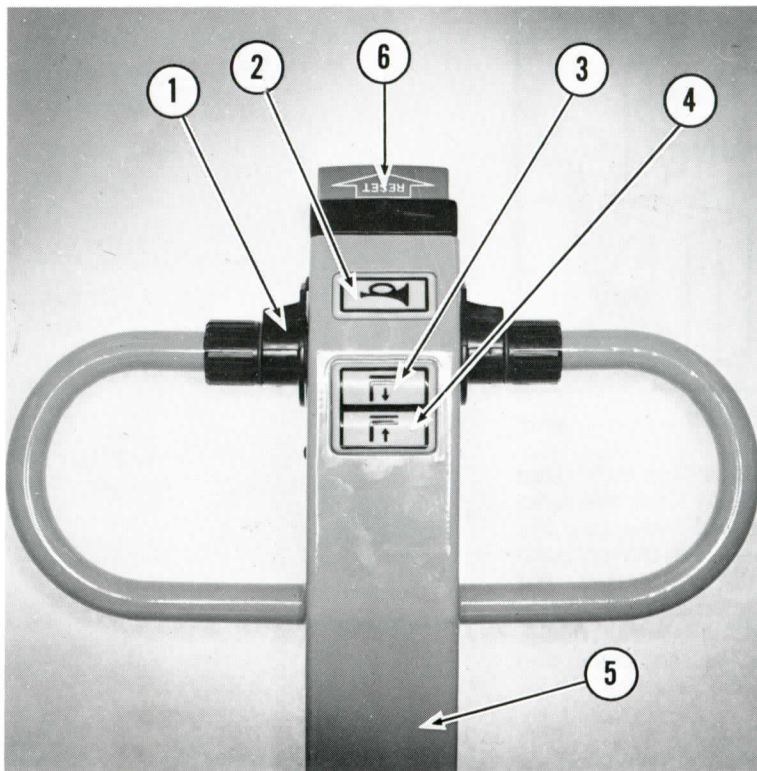

1. Forward-Reverse and Speed Control.
2. Horn Button.
3. "Lift" Control Button.
4. "Lower" Control Button.
5. Steering Control Handle and Brake.
6. Mechanical Reversing Switch.

*Brake is applied when control handle is in the "Up" or "Down" position.

23682

BEFORE OPERATION

**ELECTRIC TRUCK
DRIVER'S DAILY CHECKLIST**
Check Before Start Of Each Shift

Truck No. _____ Date _____
Operator _____ Supervisor's OK _____

Hour Meter Reading: _____
Start of Day _____ End of Day _____ Hrs. for Day _____

Needs Attention or Repair
 OK
 Needs Attention or Repair

Visual Checks:	Operational Checks:
<input type="checkbox"/> Obvious damage and leaks <input type="checkbox"/> Tire condition <input type="checkbox"/> Battery plug connection Note: Be sure the battery plug connection is tight.	<input type="checkbox"/> Horn <input type="checkbox"/> Steering <input type="checkbox"/> Service brakes <input type="checkbox"/> Battery Load Test Note: Watch battery indicator while holding oil lever on full back tilt. If needle falls to red area, battery does not have sufficient charge to operate truck properly.
<input type="checkbox"/> Head and tail lights <input type="checkbox"/> Warning lights <input type="checkbox"/> Hour meter <input type="checkbox"/> Other gauges and instruments <input type="checkbox"/> Battery Discharge indicator Note: Key on - needle should indicate in green area.	<input type="checkbox"/> Parking brake <input type="checkbox"/> Seat brake <input type="checkbox"/> Hydraulic controls

13124

Each operator must complete the daily checklist. Do all of the checks and give list to authorized personnel. See your Clark dealer for copies of the checklist sheets. If the checklist indicates that repairs are needed, do not operate the truck.



23356

Inspect the truck and look for damage and leakage. Write all damage and leakage on the daily check list, and do not operate the truck until it is repaired.

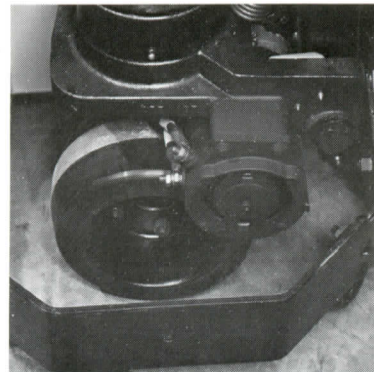

23357

Check the condition of drive wheel and tire assembly.

BEFORE OPERATION



23678

Move the control handle from "full-up" to "full-down" and return to "full-up" position while checking brake application. Truck brakes should apply in both "full-up" and "full-down" position.



23679

Lower control handle to operating position and check steering by moving handle through full 180° arc from right to left. Handle should move smoothly through the full 180°.



23691

Remove the battery cover by loosening the knobs and rotating the retainers. Visually check battery connector. Check the condition of electrical cables and wiring and make a report of all worn or cracked cables to correct authority.

BEFORE OPERATION

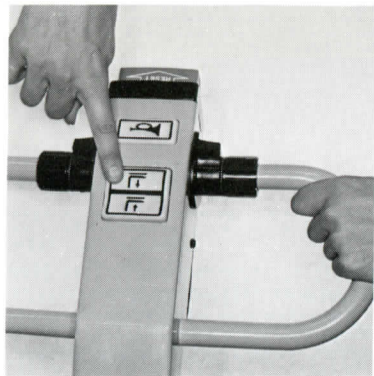

23680

Push "lift" button and hold until forks have raised to maximum height.

Release "lift" button to stop the forks from raising.

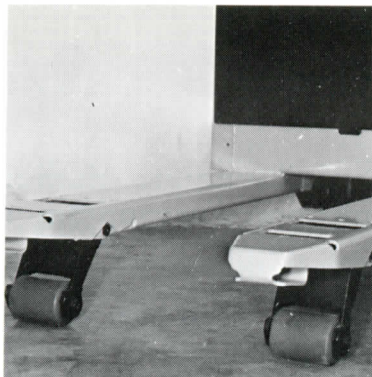

23692

Release control handle in "full-up" position (to apply brakes) then walk to pallet fork end of truck and check condition of load wheels.

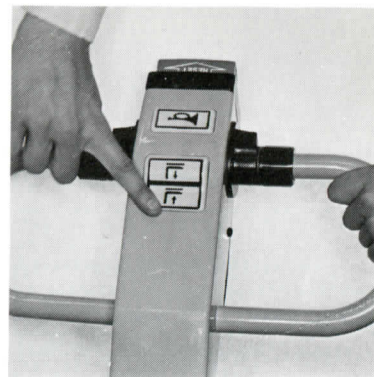

23681

Return to control handle of truck and press "lower" button to lower pallet forks.

Release "lower" button to stop the forks from lowering.

BEFORE OPERATION

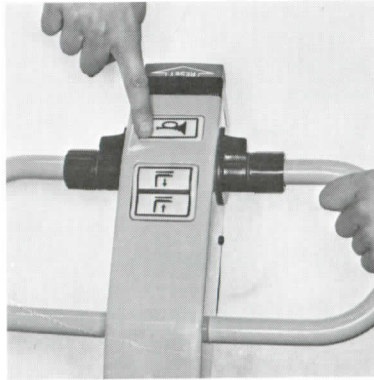

23354

Press the horn button to check horn function. If the horn does not function, report the failure and have it repaired before the truck is put into operation.



23352

Pull the control handle down to operating level and move into position in line with the path of forward or reverse travel.

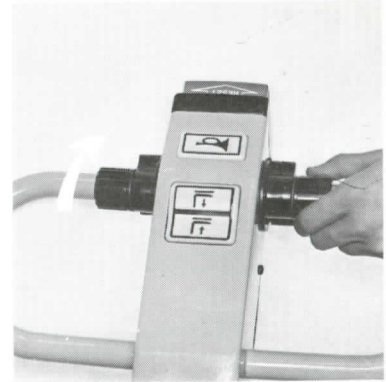

23683

Put the thumb of right (or left) hand on the forward directional control and operate the truck slowly in first speed. Truck will move forward (toward you) slowly. Travel speed may be increased by pressing more on the directional control.

BEFORE OPERATION



23678

Release thumb pressure on directional control and raise handle to apply truck brake and stop forward travel.

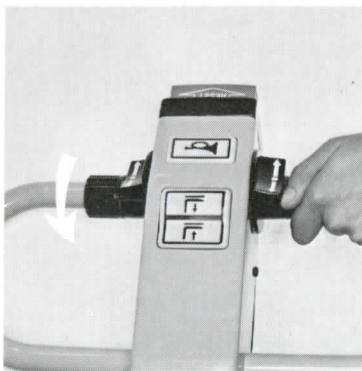

23684

Lower the handle to operating position and put thumb of right (or left) hand on the reverse directional control and operate the truck slowly in first speed. The truck will move in reverse direction (away from you).

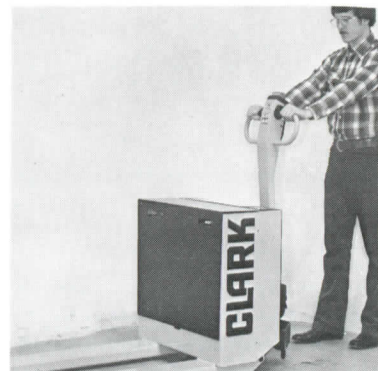

23678

Release thumb pressure on the directional control and raise handle to apply truck brake. Lower the pallet forks to floor. Repeat the brake operation check in the low handle position.

BEFORE OPERATION

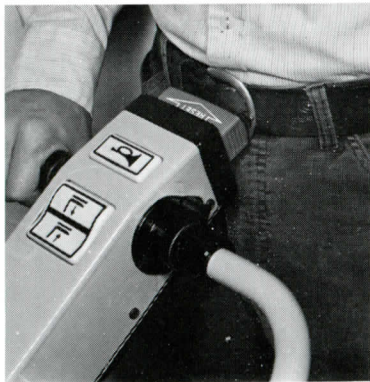

23685

Check the operation of the mechanical reversing switch. See pages 28 and 29.

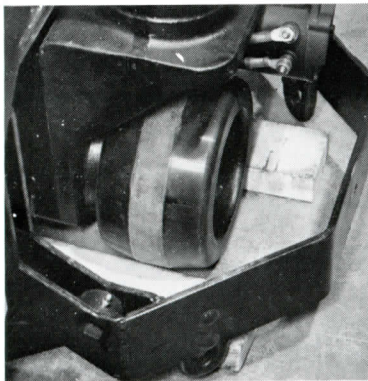

23687

Turn the control handle to the full turn position. Put blocks at the drive wheel to prevent the truck from rolling.

ELECTRIC TRUCK DRIVER'S DAILY CHECKLIST

Check Before Start Of Each Shift

Date _____
Truck No. _____
Operator _____ Supervisor's OK _____

Hour Meter Reading _____
Start of Day _____ End of Day _____ Hrs. for Day _____

Boxes Accordingly OK Needs Attention or Repair

Visual Checks	Operational Checks
<ul style="list-style-type: none"> <input type="checkbox"/> Obvious damage and leaks <input type="checkbox"/> Tire condition <input checked="" type="checkbox"/> Battery plug connection <i>Note: Be sure the battery plug connection is tight.</i> <input checked="" type="checkbox"/> Hood and tail lights <input type="checkbox"/> Warning lights <input type="checkbox"/> Hour meter <input type="checkbox"/> Other gauges and instruments <input type="checkbox"/> Battery Discharge indicator <i>Note: Key on, needle should indicate in green area.</i> 	<ul style="list-style-type: none"> <input type="checkbox"/> Horn <input type="checkbox"/> Steering <input type="checkbox"/> Service brakes <input type="checkbox"/> Battery Load Test <i>Note: Watch battery indicator while holding till lever on full back on. If needle falls to red area, battery doesn't have sufficient charge to operate truck properly.</i> <input type="checkbox"/> Parking brake <input type="checkbox"/> Seat brake <input type="checkbox"/> Hydraulic controls

13124

Review the operator's daily checklist to make sure that it has been completed. Give the check list to the person responsible for lift truck maintenance.

OPERATION



23687

Connect the battery. Remove the blocks from drive wheel and move control handle from full turn position to center of truck.

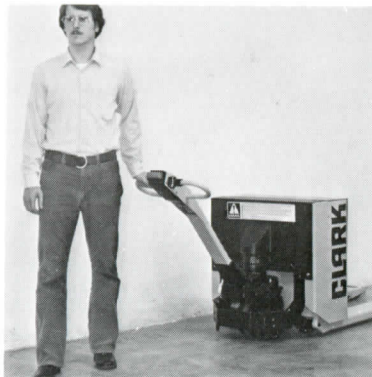

23353

Lower the control handle to operating level.
Check all around to insure that the desired path of travel is clear of obstructions and personnel.

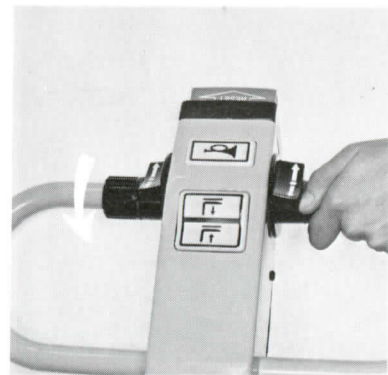

23684

Put thumb of right (or left) hand on directional control. For direction of travel, select a direction, and press the directional control for the speed you want.

OPERATION

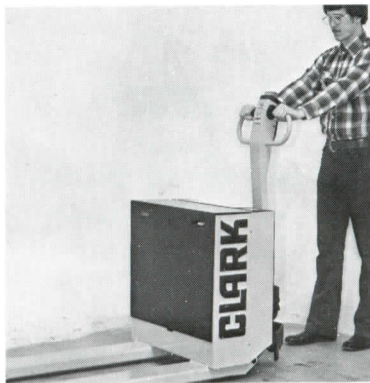

23678

To stop the truck, release the directional control and fully raise the control handle.

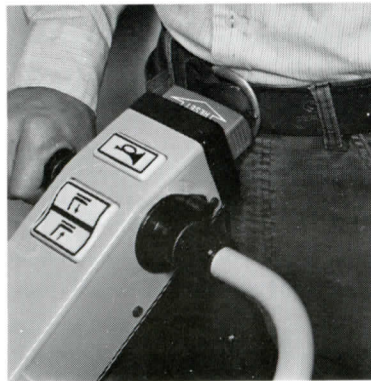

23685

Check the operation of the mechanical reversing switch: move the truck in forward direction (toward you). Permit the red mechanical reversing switch to make contact with your body (or hand), which pushes the switch in half way and turns off power to the truck.

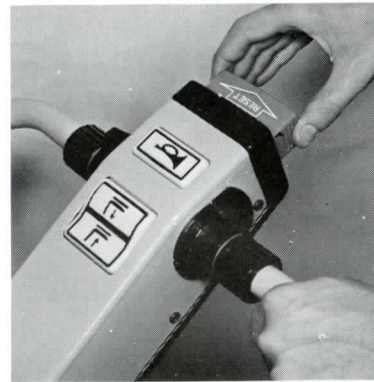

23686

Pull the mechanical reversing switch out to reset.

BEFORE OPERATION

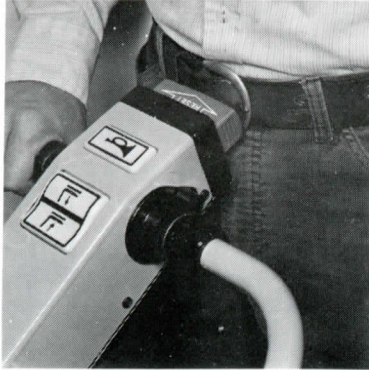

23685

Again, move the truck in forward direction. Push the mechanical reversing switch again, but harder, pushing the switch all the way in. The truck will move away from you for a moment, and return to half way position, turning off power to the truck. Reset the switch.

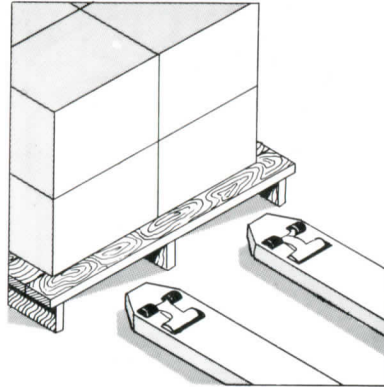

14680

Enter the load carefully. The forks must be fully under the load to provide good stability and balance.

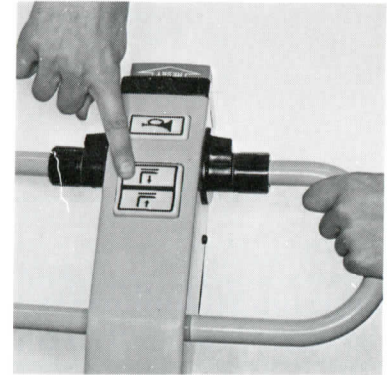

23680

Before lifting the load make sure there are no obstructions in the lift area. Push the "lift" switch and hold until load reaches "full-up" position.

OPERATION

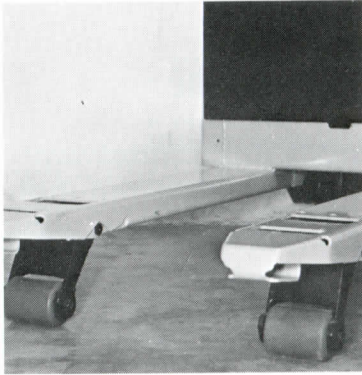

23692

Remember to travel with load raised fully to give clearance necessary to prevent pallet contact with floor.

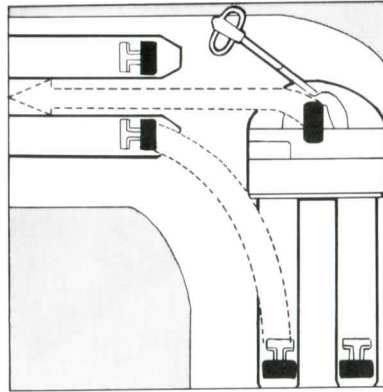

23768

Use caution when making right or left turn into aisle. Remember that trail wheels do not follow the turn path of the drive wheel.

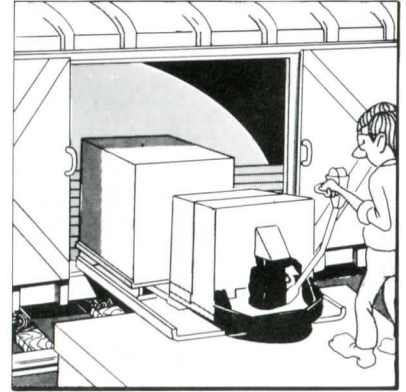

23776

Areas such as elevators, semi-trailers, trucks or boxcars must be entered in reverse (trail frame first) to make it easier to leave them.

OPERATION

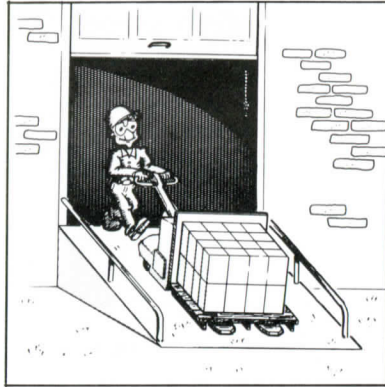

21499

When moving up or down a grade, the forks should be kept downgrade with or without a load on the truck.

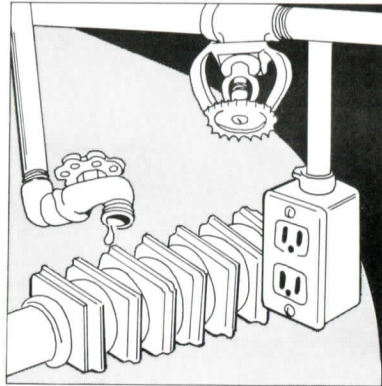

13104

Be careful when putting loads near water pipes, electrical wiring or outlets, steam pipes, heaters and other equipment or material.

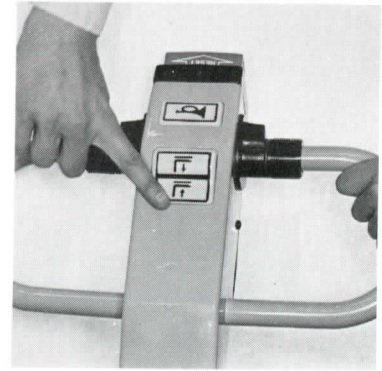

23681

When the load is in position, push the "lower" button and hold until the pallet forks are lowered as far as possible.

OPERATION



23352

Pull the control handle down to operating level.

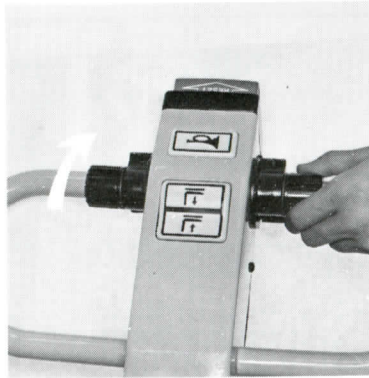

23683

Put the thumb of right (or left) hand on the forward directional control and operate the truck slowly in first speed.

The truck will move forward (toward you) pulling the truck forks from the pallet.



23356

Look and listen for unusual truck operation.

Report any problems immediately so that adjustments or repairs may be made by trained and qualified personnel.

PARKING

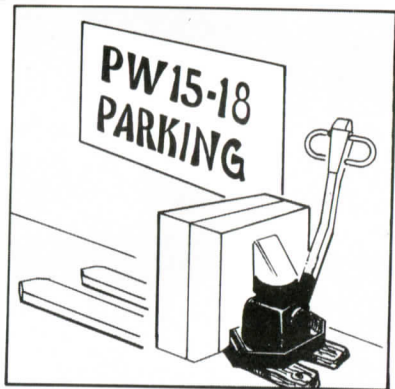

23775

Park the truck in approved areas only.

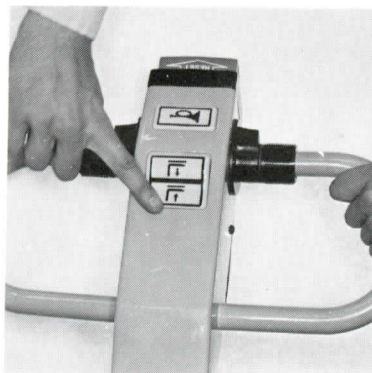

23681

Lower the pallet forks.

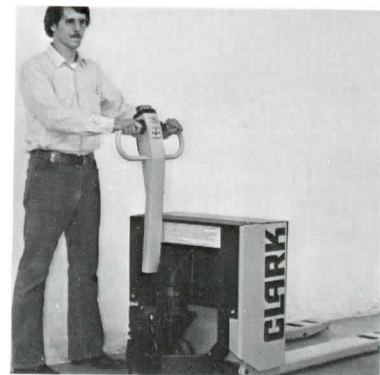

23688

Put control handle in full turn position and raise the handle to "full-up" position so that truck brake is applied.

PARKING

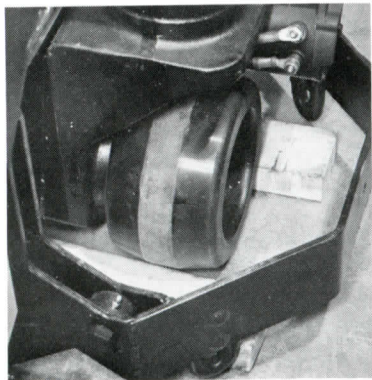

23687

Put blocks at the drive wheel to prevent the truck from rolling.

CHARGING AUTOMOTIVE BATTERIES



23691

Remove battery cover.

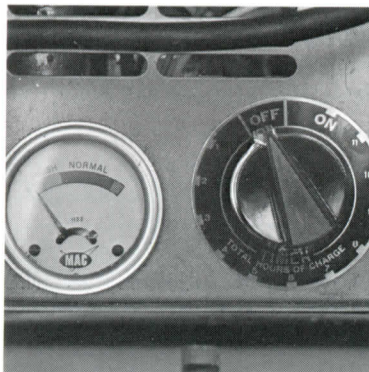

23693

Disconnect the battery from the truck receptacle and turn the timer to the "Off" position.

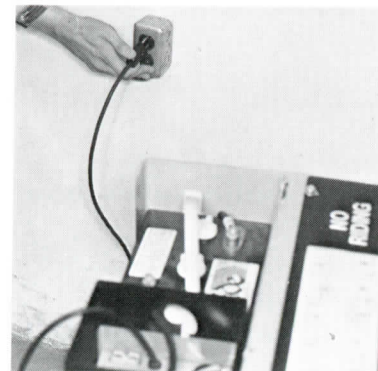

23694

Connect the AC cord to a 115V. AC outlet line (or a 230 V. AC outlet, according to type of charger).



CAUTION

DO NOT OPERATE THIS CHARGER UNLESS IT IS CONNECTED TO THE BATTERIES.

CHARGING AUTOMOTIVE BATTERIES

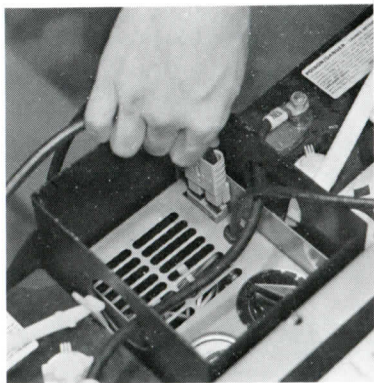

23695

Connect the battery receptacle to the charger.

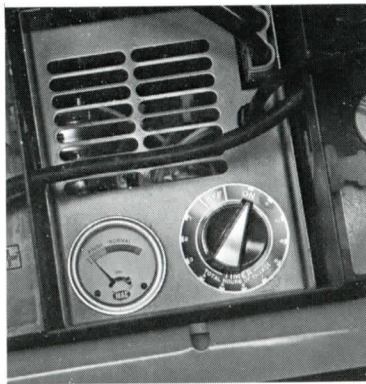

23696

Turn the timer to the "On" position. The pilot light and ammeter shows the charger is on and charging. When the timer is turned to "On" position, the charger will run as set, or a maximum of 12 hours.

NOTE

The charger may stay connected to the batteries for long periods of time without damage to the charger, and without discharging the batteries.

CHARGING AUTOMOTIVE BATTERIES

IMPORTANT

Weekly Check: After charging, check the height of electrolyte in each battery cell. Add distilled water if necessary, then, after batteries have been charged, connect the batteries to the charger and set the time clock pointer to #4 on the timer dial. This added charging time will keep the cells equal to one another and help keep the batteries in good condition. Weekly checks are to be performed only by trained and authorized battery maintenance personnel.

CHARGING INDUSTRIAL BATTERIES

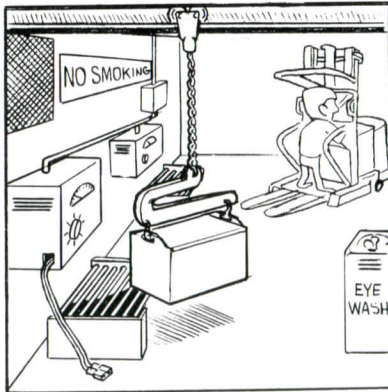

13105

Batteries should be serviced or charged only in charging areas and only by personnel trained in safe battery maintenance.

**WORK SAFELY! FOLLOW
NORMAL AND APPROVED
METHODS FOR CHARGING
INDUSTRIAL BATTERIES.**

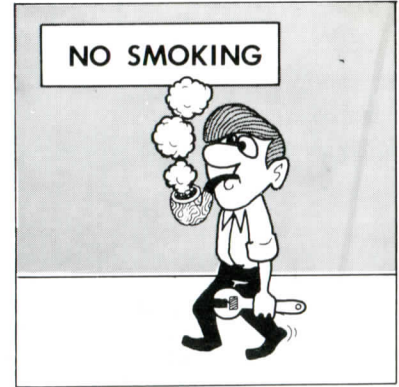

13107

Never smoke or permit anyone to smoke in areas where batteries are being charged or in areas where fuel or other flammable fluids or materials are kept or used.

BATTERY RETAINMENT

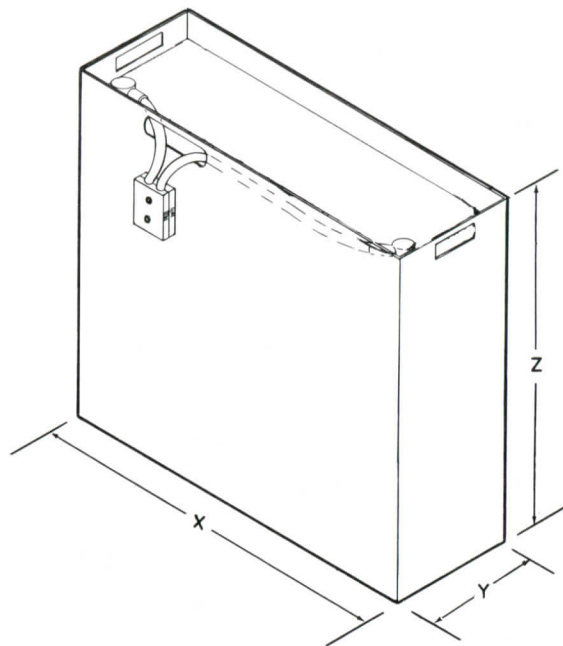

IMPORTANT

USE ONLY THE FOLLOWING 24-VOLT INDUSTRIAL BATTERY SIZES (WITHOUT COVER) AND AH/KWH (6-HR. RATING) WITH THE PROVIDED BLOCKING.

X mm/in.	Y mm/in	Z mm/in.	AH/KWH
608,0/23.94	168,0/6.63	575,0/22.63	150/3,5
608,0/23.94	168,0/6.63	575,0/22.63	170/4,0
638,0/25.12	168,0/6.63	590,5/23.25	170/4,0
608,0/23.94	168,0/6.63	651,0/25.63	190/4,47
638,0/25.12	168,0/6.63	651,0/25.63	200/4,70

FOR OTHER INDUSTRIAL BATTERY SIZES, PROVIDE BLOCKING TO RESTRAIN THE BATTERY FROM MOVING NOT MORE THAN 12,7 MM/.50 IN. IN A HORIZONTAL DIRECTION.

IN THE AUTOMOTIVE BATTERY PACK, USE ONLY 4 (FOUR) 6-VOLT DEEP CYCLE BATTERIES HAVING AT LEAST 146 AH 3.4 KWH (6-HR. RATING):

FOR FURTHER UL SPECIFICATIONS COVERING BATTERY CONSTRUCTION SEE DECAL ON THE INSIDE OF REAR COVER.

ELECTRIC TRUCK BATTERY SPECIFICATIONS

BATTERY MUST COMPLY WITH THE FOLLOWING PARAGRAPHS FROM U/L 583 STANDARD FOR ELECTRIC BATTERY POWERED INDUSTRIAL TRUCKS, COVERING CONSTRUCTION

11. Battery Compartment and Enclosure

- 11.1 Support and protection shall be provided for the battery by means of a noncombustible enclosure.
- 11.2 A metal battery enclosure shall not be less than 0.053 inch (1.35 mm) thick. A metal battery enclosure shall be flanged not less than 1/2 inch (12.7 mm) on all sides or be provided with a construction that gives equivalent strength.
- 11.3 The cover of a battery enclosure shall remain closed by the force of gravity or shall be provided with a fastener.
- 11.4 A metal cover for a battery enclosure shall:
 - A. Have such strength and rigidity that, in conjunction with an air spacing provided between it and the battery terminals, the battery terminals are not short-circuited when a 250 pound (1110 newton) force is applied to any one-square-foot [930-square centimeters (cm²)] area of the cover; or
 - B. Have insulation secured to the inner surface designed to prevent short-circuiting of the battery terminals.
- 11.5 The battery enclosure shall be provided with means for ventilation that minimizes the possibility of accumulation of explosive hydrogen-air mixtures above the battery.

ELECTRIC TRUCK BATTERY SPECIFICATIONS

- 11.6 Means shall be provided as a part of the truck to restrain a battery of nominal voltage rating and representative of maximum ampere-hour capacity rating from moving more than a total of 1/2 inch (12.7mm) in a horizontal direction.
12. Battery
- 12.1 A battery furnished with a noncombustible tray and cover intended to form the ultimate enclosure for the battery shall comply with the requirements in paragraphs 11.1-11.5.
- 12.2 Cells employing metal containers, such as alkaline batteries, shall be insulated from one another and from a metal tray or metal battery compartment. Insulation of wood or other material shall be (1) treated or painted to minimize deterioration by the battery electrolyte, and (2) constructed to minimize the risk of damage to the insulation in the normal operation and maintenance of the truck.
- 12.3 The connections shall be such that the potential between any two adjacent cells cannot be more than 24 volts nominal.
13. Battery Leads
- 13.1 A battery lead shall be of a size and ampacity acceptable for the application. It shall be (1) neoprene-insulated or insulated with an equivalent material, (2) resistant to acids or alkalies, and (3) able to withstand flexing, handling, and impact at temperatures between 54 °C (130 °F) and minus 29 °C (minus 20 °F). The average insulation thickness shall not be less than 0.060 inch (1.52 mm) for a No. 8-2 AWG (8.4-33.6 mm²) wire and shall not be less than 0.080 inch (2.03 mm) for a No. 1-4/0 AWG (42.4-107.2 mm²) wire.

ELECTRIC TRUCK BATTERY SPECIFICATIONS

14. Battery Connection

- 14.1 A truck shall be equipped with a battery connector located to provide mechanical protection as required for other electrical parts of the truck.
- 14.2 One part of the connector shall be permanently mounted to either the truck or the battery enclosure. The length of the cable attached to the free part of the connector shall be as short as practicable, without interfering with the disconnecting operation and without placing stress on terminals.
- 14.3 Live parts shall be recessed from the face of the connector to minimize the possibility of shorting.
- 14.4 The removable portion of the connector shall be provided with means for being grasped during removal.
- 14.5 A battery connector shall have the proper rating for use in its particular application.

FOR EE CONSTRUCTION BATTERIES MUST COMPLY WITH THE FOLLOWING ADDITIONAL PARAGRAPHS:

- 36.1 The battery enclosure shall be provided with a cover with means for locking it in the closed position to deter opening by unauthorized persons. Insulation designed to prevent shorting of the terminals shall be secured to the inner surface of a metal enclosure, over the terminals.

ELECTRIC TRUCK BATTERY SPECIFICATIONS

36.2 All upper openings shall be covered with a heavy-gauge wire mesh, expanded metal, or a perforated cover. The size and shape of the opening shall not permit passage of a rod having a diameter greater than 1/2 inch (12,7 mm). If the distance between an uninsulated live part and the opening is greater than 4 inches (101.6mm), the opening may be larger than that previously mentioned, provided no opening will permit passage of a rod having a diameter greater than 3/4 inch (19,0mm). The diameter of the wires of a screen shall be no less than 0.051 inch (1.30 mm) if the screen openings are 1/2 square inch (3.2 cm²) or less in area, and shall be no less than 0.081 inch (2.06 mm) for larger screen openings. Perforated sheet steel and sheet steel employed for expanded-metal mesh shall be no less than 0.042 inch (1.07 mm) in thickness if uncoated and no less than 0.045 inch (1.14 mm) if zinc-coated for mesh openings or perforations 1/2 square inch (3.2 cm²) or less in area. They shall not be less than 0.080 inch (2.03 mm) in thickness if uncoated and no less than 0.084 inch (2.13 mm) if zinc-coated for larger openings.



Additional copies of this manual may be purchased from:
YOUR AUTHORIZED CLARK DEALER

CLARK Industrial Truck
Division

Battle Creek, MI 49016
Georgetown, KY 40324
St. Thomas, Ontario, Canada N5P1H2
5CG Sept. 82 Printed in U.S.A.