

Operator's Manual

Do not remove this manual
from the truck.

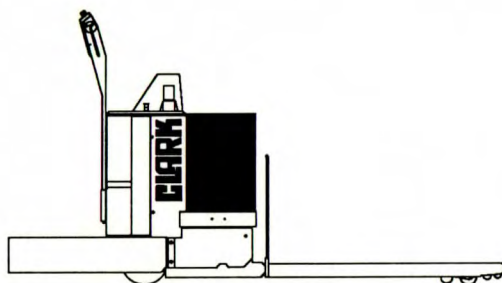

AGP 40

CLARK

Book No. 2772956
OM - 551

$5\frac{1}{4} \times 8\frac{1}{4}$

Operator's Manual

You must be trained and authorized to operate a lift truck

YOU can prevent accidents!

First: Learn safe operating rules and your company rules.

Next: Read and understand your Operator's Manual.

Learn about the unit you operate.



KNOW YOUR TRUCK

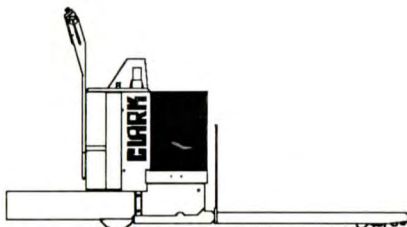

Then: Practice operating your truck safely.

And: Keep your truck in safe operating condition with correct and timely maintenance.

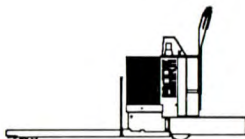

Breaking these rules will cause serious or fatal injury to yourself and others.

A Message to CLARK Customers

Experience with lift truck accidents has shown that when accidents happen and people are killed or injured, the cause has its roots in three areas; the selection of operators, their training and their supervision.

When lift truck operators are selected you must consider people who can become responsible professional operators. Lift trucks are not cars and they're not ordinary trucks. They are specialized machines with specialized operating characteristics designed to perform specialized jobs. Under the Occupational Safety and Health Act you must train your lift truck operators. That is your responsibility. We are here to help, but only you know how a specific machine is used. Only you can properly train your operators for the jobs they must perform. Once they are trained and you are absolutely sure they know how to operate the equipment and follow basic safety rules, you must make sure they do. If you don't, the results can be accidents that end up in costly damage to your products, your facilities, your equipment, and worst of all, serious injury or death to the people who use these machines or work around them.

The operator's manual is not a training manual. It is a guide to help trained and authorized operators safely operate their lift truck by emphasizing and illustrating the correct procedures. But, it cannot cover every possible situation which may result in an accident. You must watch for hazards in your work areas and avoid or correct them. It is important that you know and understand the information in this manual as well as to know and follow your company safety rules! Be sure that your equipment is maintained in a safe condition. Do not operate a damaged truck. And practice safe operation every time you use your lift truck. Let's join together to set new standards in safety.

Message to CLARK Lift Truck Operators

Lift trucks are specialized machines with unique operating characteristics designed to perform specific jobs. Their function and operation is not like a car or ordinary truck. They require specific instructions and rules for safe operation and maintenance.

Safe operation of lift trucks is of primary importance to CLARK. Our experience with lift truck accidents has shown that when accidents happen and people are killed or injured, the causes are:

OPERATOR NOT PROPERLY TRAINED

OPERATOR NOT EXPERIENCED WITH LIFT TRUCK OPERATION

BASIC SAFETY RULES NOT FOLLOWED

LIFT TRUCK NOT MAINTAINED IN SAFE OPERATING CONDITION

This manual is designed to help you operate your lift truck safely. This manual shows and tells you about safety inspections and the important general safety rules and hazards of lift truck operation. It describes the special components and features of the truck and their function. The correct operating procedures are shown and explained. Illustrations and important safety messages are included for clear understanding. And, a section on maintenance and lubrication is included for the lift truck mechanic.

The operator's manual is not a training manual. It is a guide to help trained and authorized operators safely operate their lift truck. But, it cannot cover every possible situation. You must watch for hazards in your work areas and avoid or correct them. It is important that you know and understand the information in this manual. Know and follow your company safety rules. Be sure that your equipment is maintained in a safe condition. Do not operate a damaged truck.

Be sure that you understand all driving procedures. Federal Occupational Safety and Health Act (OSHA) and state laws require that operators be completely trained in the safe operation of lift trucks.

CLARK lift trucks are built to take hard work, but not abuse. They are built to be dependable, but they are only as safe and efficient as the operator and the persons responsible for maintaining them.

Do not make any repairs to this truck unless you have been trained in lift truck repair procedures and authorized by your employer.

CONTENTS

A MESSAGE TO CLARK LIFT TRUCK CUSTOMERS	ii
A MESSAGE TO CLARK LIFT TRUCK OPERATORS	iii
ABOUT THIS MANUAL	v
TRUCK APPLICATION	vi
1 GENERAL SAFETY RULES AND PRACTICES	1.1
2 OPERATING HAZARDS	2.1
3 KNOW YOUR TRUCK	3.1
4 OPERATOR CARE AND MAINTENANCE	4.1
5 OPERATING PROCEDURES	5.1
MANUAL OPERATION	
AUTOGUIDE OPERATION	
6 EMERGENCY TOWING	6.1
7 MAINTENANCE AND LUBRICATION	7.1

About This Manual

The purpose of this manual is to provide a digest of essential information about the safe operation of your lift truck and to acquaint you with its features and how they function and are maintained.

This manual has been printed on a special weather resistant material and is intended to remain on, and be a permanent part of this lift truck.

Be sure to put this operator's manual back in the holder when not in use.

NOTICE - - The descriptions and specifications included in this manual were in effect at the time of printing. Clark Equipment Company reserves the right to make improvements and changes in specifications or design, without notice and without incurring obligation. Please check with your authorized Clark dealer for information on possible updates or revisions.

TRUCK APPLICATION

This truck is designed for a specific application. Make sure you are using this truck correctly for the job it was intended to do.

Utilizing a combination of manual and automatic modes, the CLARK AGP 40/60 is designed for the transportation of loads from one point to another over hard, flat surfaces. The load is manually installed on the vehicle and placed on a guide-path, where it travels automatically to its programmed destination. There, it unloads its cargo, and if so programmed, is capable of continuing on to the next destination under its own accord.

1 General Safety Rules Index

Safety Alert Symbol	1.2
Daily Inspection	1.3
Do's and Don'ts	1.3
Operating	1.4
No Riders	1.5
Pedestrians	1.5
Fork Safety	1.6
Pinch Points	1.6
Surface & Capacity	1.7
Loading Docks	1.7
Grades, Ramps, Slopes and Inclines	1.8
Travel	1.9
Load Position	1.9
Parking	1.10
Floor Markings	1.11
Clean Floor Path	1.11
Expansion Joints	1.11
Signs in Operating Area	1.12

IMPORTANT NOTICE



This is the industry's "Safety Alert Symbol". This symbol is used to call your attention to items or operations that could be dangerous to you or other persons using this equipment. It is essential that you read the instructions and safety regulations before you attempt to assemble or use this unit.

PRELIMINARY SERVICE

Examine your Clark Electric Truck carefully to determine if it has been damaged in shipment. Any damage should be reported immediately to the transportation company.

OPERATION

This truck has been designed for level floor operation and should be operated in accordance with instructions in ANSI B 56. 1 - 1969-1975.

General Safety Rules Daily Inspection



At the beginning of each shift inspect your truck and fill out a daily inspection sheet. Check for damage and maintenance problems. Have repairs made before you operate the truck.



Do not make repairs yourself. Lift truck mechanics are trained professionals. They know how to make repairs safely.

Do's And Don'ts



DON'T MIX DRUGS AND ALCOHOL WITH YOUR JOB.



DON'T BLOCK SAFETY OR EMERGENCY EQUIPMENT.



DO WATCH FOR PEDESTRIANS.



DON'T SMOKE IN "NO SMOKING" AREAS.



DO WEAR SAFETY EQUIPMENT WHEN REQUIRED.

General Safety Rules Operating

1. Do not operate this truck unless you have been trained and authorized to do so. Read all warnings and instructions in operator's manual and on this truck.
2. Do not operate this truck until you have checked its condition. Give special attention to tires, horn, battery, controller, lift linkage, forks, limit switches, brake, steering handle, bumper and operator safety equipment.
3. Operate truck only from designated operating position.
4. Do not handle unstable or loosely stacked loads. Use special care when handling long, high or wide loads to avoid losing the load, striking bystanders, or tipping the truck.
5. Do not overload truck. Check capacity plate for load weight information.
6. Pallet trucks will tip over if not operated correctly. Start, stop, travel, steer and brake smoothly. Slow down for turns and avoid uneven or slippery surfaces that could cause truck to slide or overturn. Operate carefully when traveling without a load as the risk of overturn is greater.
7. Elevate forks only to pick up a load or when traveling up or down a grade.
8. Always look in direction of travel. Keep a clear view. When load interferes with visibility, make sure path is clear of personnel and objects before proceeding.
9. Use caution when operating truck on ramps or inclines.
10. Observe applicable traffic regulations. Yield right-of-way to pedestrians. Slow down and sound horn at cross aisles and wherever vision is obstructed.
11. Before lifting, make sure load is centered and forks are completely under load.
12. Do not put any part of your body under the forks or load.
13. Do not carry other personnel on the forks.
14. Before leaving the truck, make sure the forks are lowered and power is off. Do not park truck on an incline.

General Safety Rules Pedestrians

Watch where you are going.

Pedestrians may use the same roadway you do.

Sound your horn at all intersections.

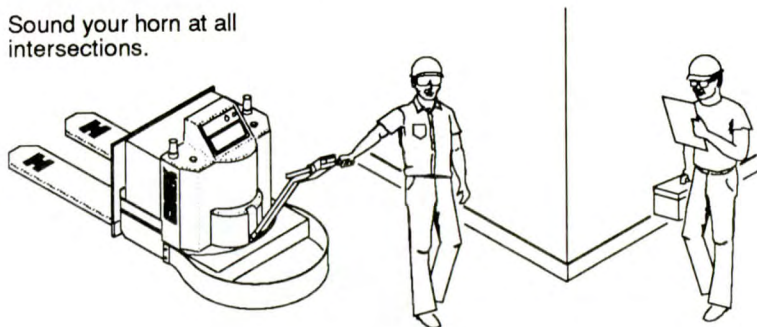

Watch for people in your work area. They may not watch for you.

No Riders

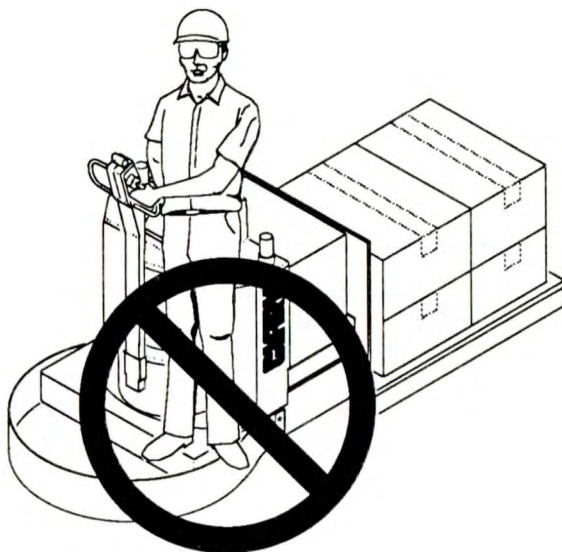

Always walk with AGP model trucks. Never attempt to ride.

General Safety Rules Fork Safety

Never allow anyone to reach under or around the edge of the truck.

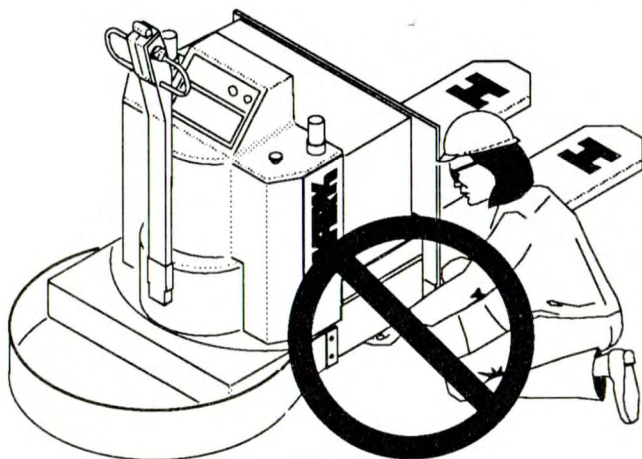

Be especially careful to not put any portion of your body under or around the edge of the forks.



Pinch Points

Never put your hand under the forks or into the lift unit mechanism unless the unit is emergency stopped, the power is disconnected and the lift unit is blocked.

General Safety Rules

Surface And Capacity

Avoid or slow down on these conditions...
They can cause a truck to tip over.

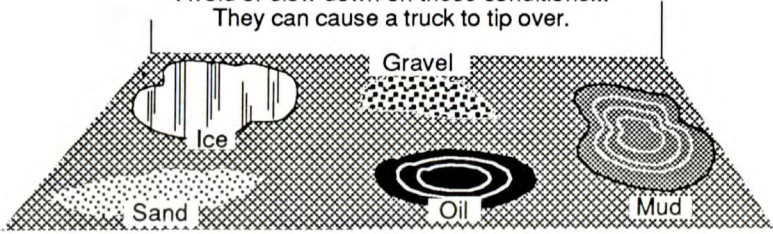

Floors

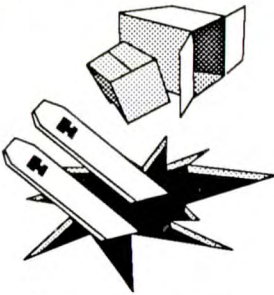

Elevators

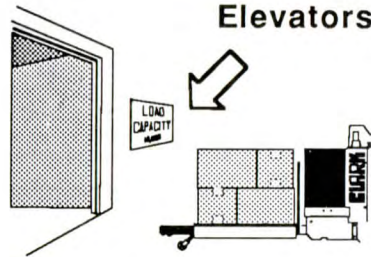

Know the weight of your truck and load. Check capacities.

Loading Docks

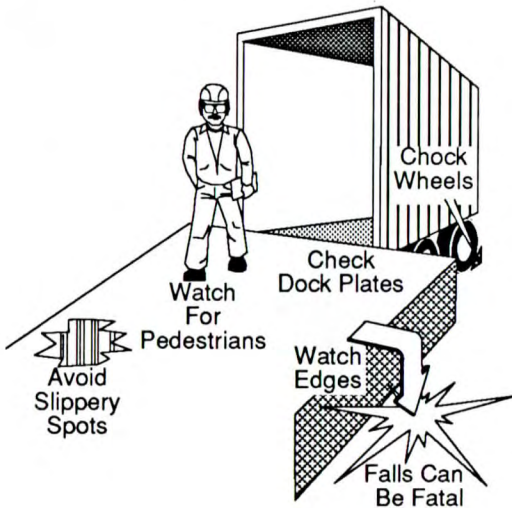

General Safety Rules Grades, Ramps, Slopes and Inclines

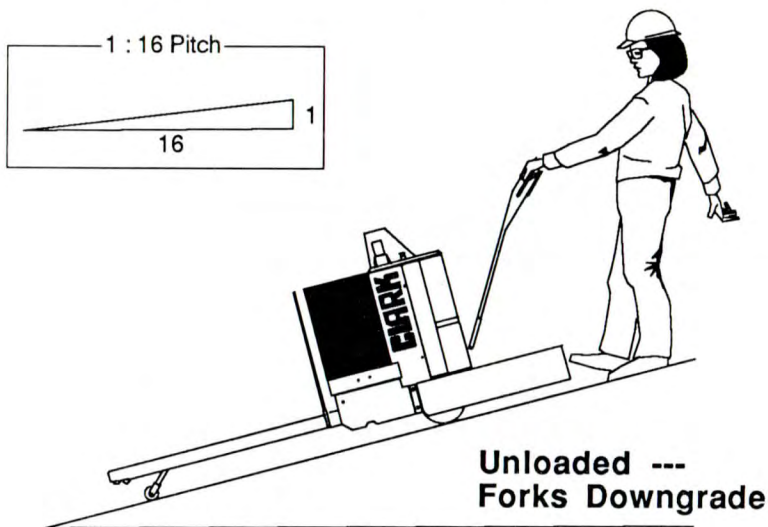

Always keep forks downgrade and in the raised position when working on a grade.

Allow clearance for the antenna located on underside of the vehicle. Trucks are designed to travel up a 1: 16 maximum pitch with or without a load.

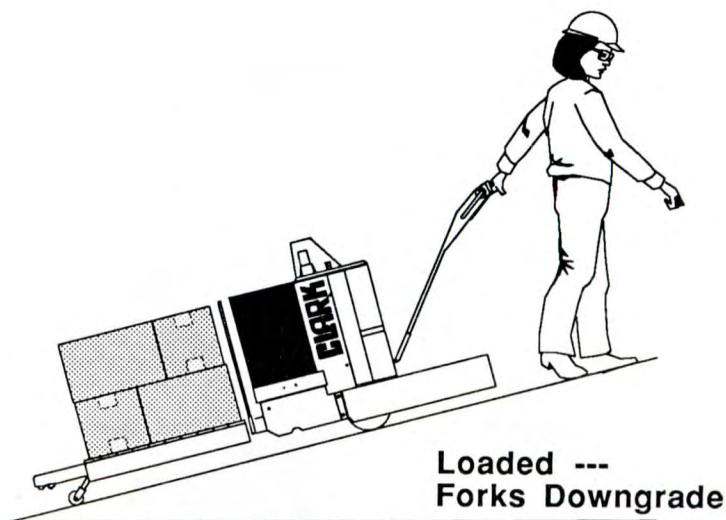

General Safety Rules Travel

Never turn on a grade.

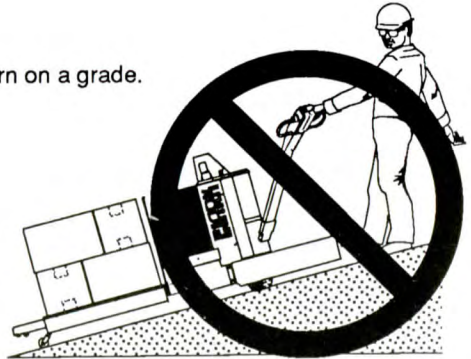

Enter confined areas such as semitrailers, trucks, boxcars or elevators with load end of your truck first.

This will minimize the maneuvering necessary to exit.

If load blocks your view while traveling in reverse, make sure path is clear of personnel and obstructions.

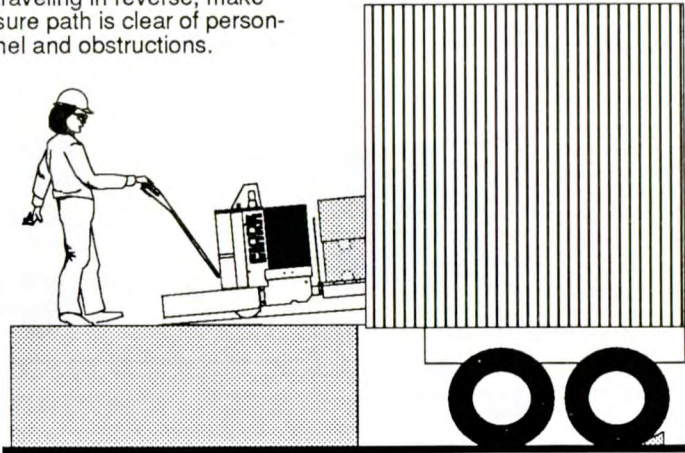

Load Position

Carry loads in a raised position. Be sure the load is straight and all the way to the back of the forks.

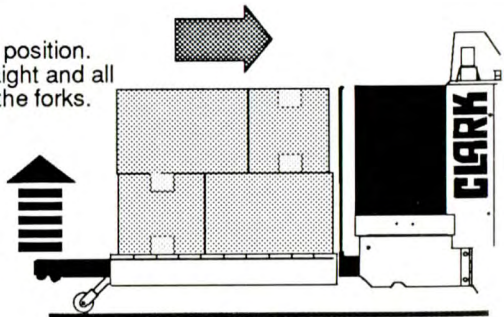

General Safety Rules Parking

Park trucks in designated parking area only.

Do not obstruct traffic lanes or aisles.

Never park on a grade.

Lower forks fully to floor.

Place control handle in full turn and raise handle to full up position so that truck brake is applied. Turn key off (if equipped) and remove.

Block drive wheel to prevent accidental roll.

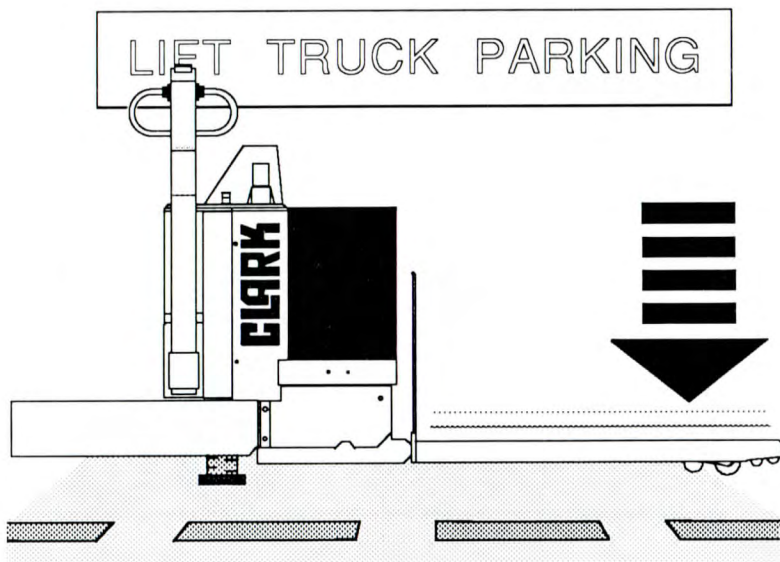

General Safety Rules Floors

Floor Markings

The surfaces and areas where the unit operates should be clearly marked.

Mark the floors at loading stations where loads are placed manually, but are picked up by an AGV.

Restart locations should be clearly marked if special places exist for inserting the unit in the system.

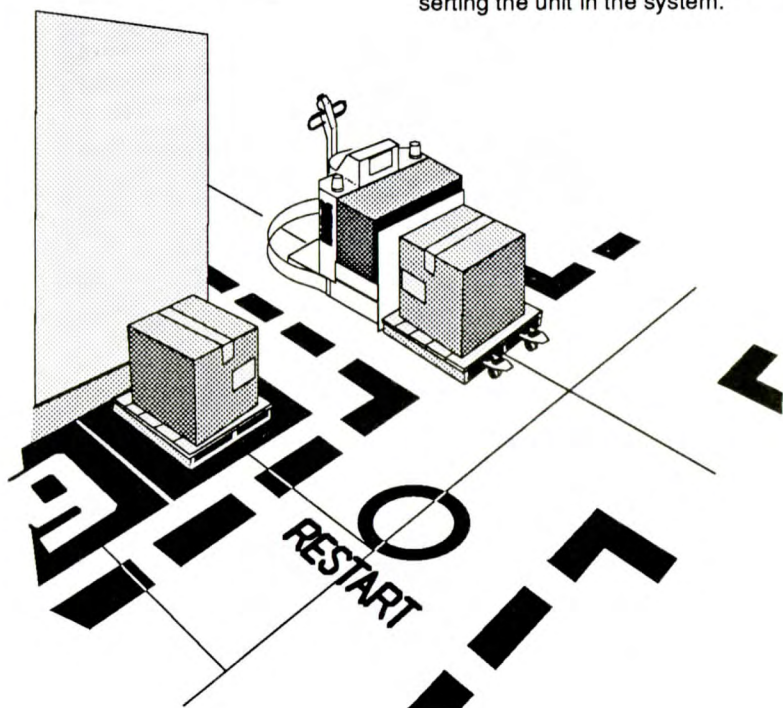

Floor Path

Guide-path should be kept unobstructed.

Keep floor clean from debris in all areas that the unit is operating.

Expansion Joints

Inspect slab expansion joints regularly in area where unit operates. Look for any movement or cracking.

General Safety Rules Signs in Operating Area

Place warning signs in areas where unit operates.

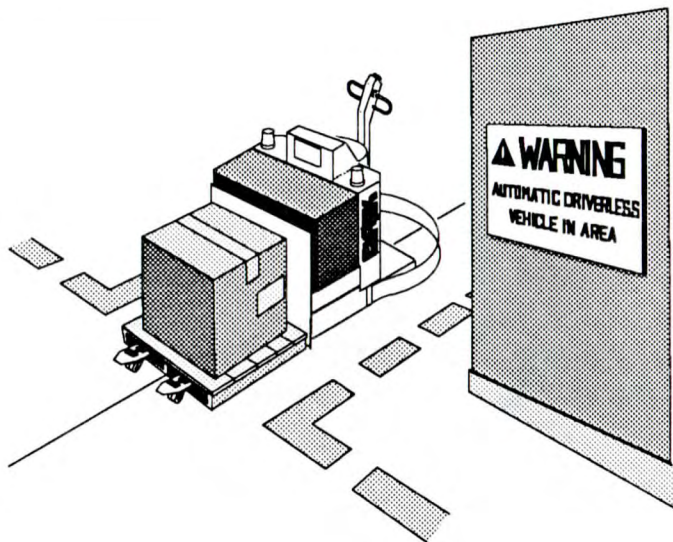

If unit is operated outside,
install warning signs for
vehicles and pedestrians.

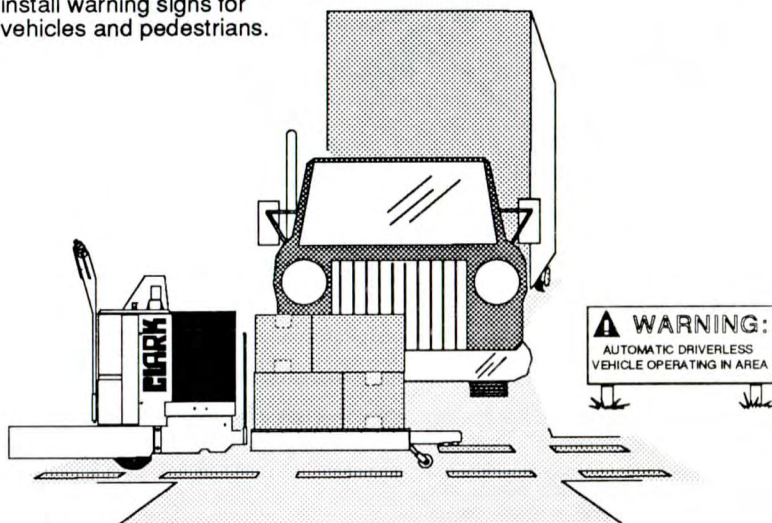

2 Operating Hazards Index

- Loose and Uneven Loads 2.2
- Long and Wide Loads 2.2
- Fast Turns 2.3
- Pallets and Skids 2.3
- Drop-offs 2.4



This section shows hazards that may cause you, or someone around you, to be killed or badly hurt. As the operator, you must look for other hazards. Get your boss to help you identify and avoid those hazards.

Operating Hazards

Be thoroughly trained in the operation of the steering, brake, and controls of this truck.

Certificate
Operator Training

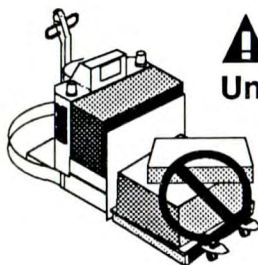

⚠ WARNING:
Uneven Loads

Never carry
uneven material.

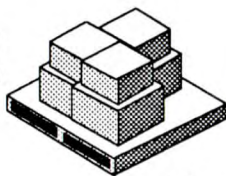

Stack loose
material evenly.

⚠ WARNING:
Long and Wide Loads

With long or wide loads you need more room,
so slow down and watch your clearance.

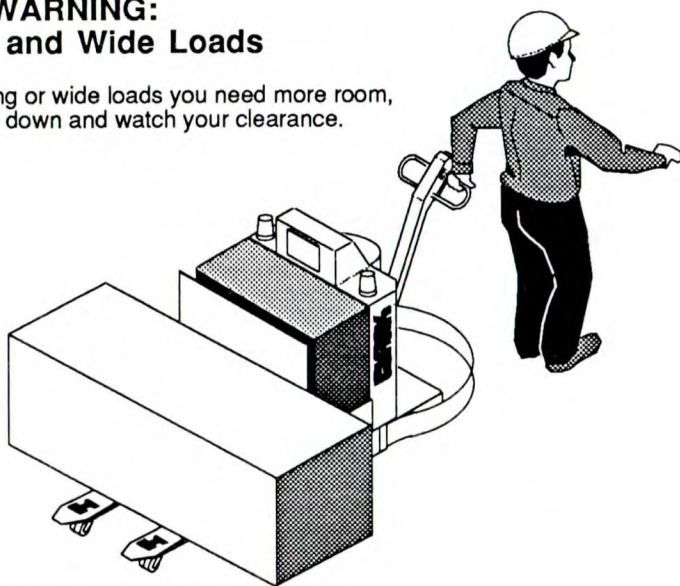

Center wide loads and watch
load balance.

Operating Hazards Fast Turns

WARNING;

Slow down before turning. Truck can tip over.

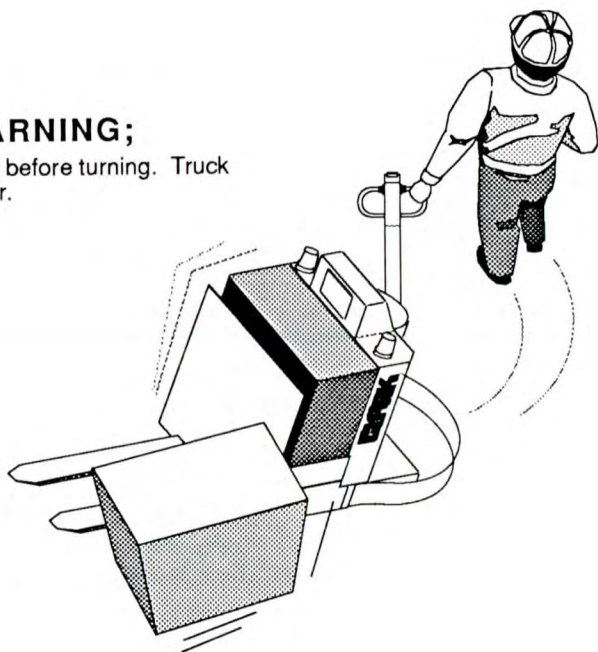

Pallets and Skids

WARNING:

Poorly maintained and/or damaged pallets and skids.



Do not move or store materials on damaged pallets or skids. Items can fall through them causing severe injury or death.



Be sure that pallet or skid you are using is in good condition and does not have defective or missing components and fasteners.

Operating Hazards Drop-offs



Warning: Dock or Trailer Drop-offs

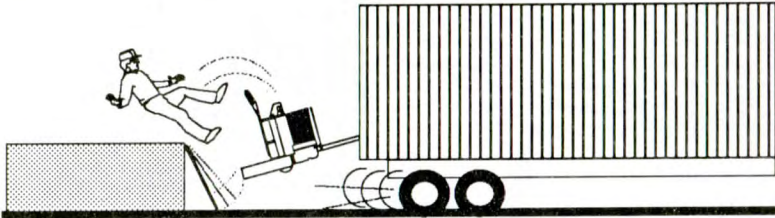
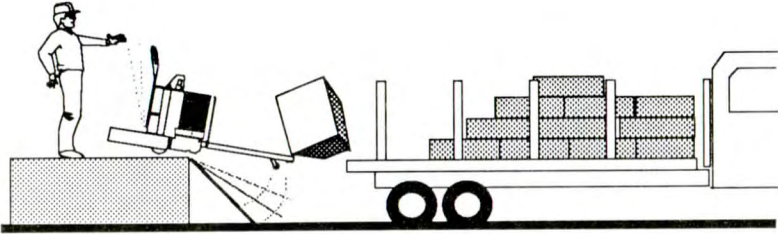

TO AVOID THESE HAZARDS YOU MUST:

Talk to the truck driver yourself, make sure he does not move the trailer until you are done!

Apply trailer brakes.

Use wheel chocks.

Use trailer-to-dock locking systems, if available.



Warning: Trailer Creep

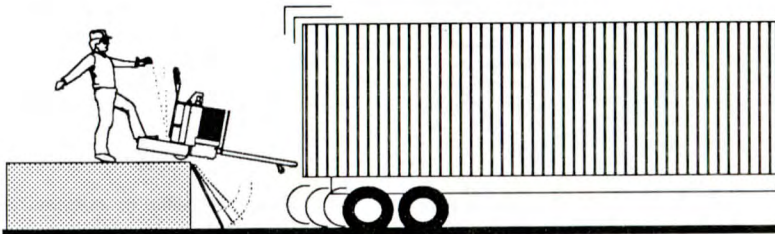

3 Know Your Truck Index

- Truck Model Description 3.2**
- Truck Data And Safety Plates 3.3**
- Safety And Warning Decals 3.5**
- Operator's Manual Controls 3.6**
- Autoguide Control Panel 3.7**
- Computer Console 3.8**

Know Your Truck Truck Model Description

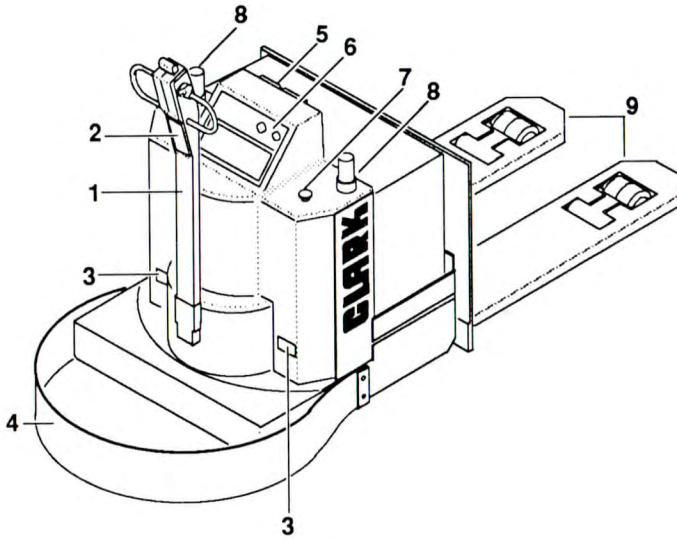

1. Manual Control Handle
2. Truck Data Plate
3. Slow Speed Sensors
4. Bumper
5. Operator's Manual
6. Autoguide Control Panel
7. Emergency Stop Buttons
8. Truck Warning Lights
9. Load Forks

Know Your Truck Truck Data and Safety Plates

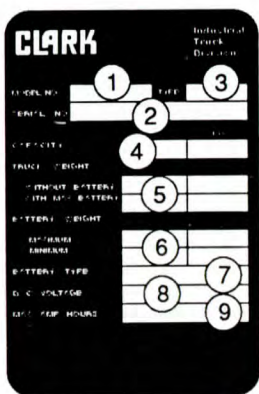

KNOW AND UNDERSTAND THE MEANING OF THE DATA ON YOUR TRUCK'S NAMEPLATE

1 & 2. Truck model number and serial number. These are identification numbers assigned to this particular truck and should be used when requesting any information or when ordering service parts for this truck from your authorized CLARK dealer. The serial number is also stamped in the frame.

3. Type designation. The code letters signify the type of construction with safeguards against fire, explosion or electrical shock hazards for operation in nonclassified and classified areas. Check with proper authority before entering areas where flammable or explosive material may be present.

4. Capacity rating. This shows the maximum load capacity of this truck. Personal injury and damage to the truck can occur if these capacities are exceeded. **DO NOT EXCEED MAXIMUM SPECIFIED.**

5. Truck weight, less load, with and without battery.

6. Battery weight.

7. Battery type.

8. System voltage.

9. Battery ampere-hour rating.

IMPORTANT - When attachments are added or if the truck is modified, the capacity of the truck may be affected. Contact your authorized Clark dealer for new nameplate showing the revised capacity.

Know Your Truck Truck Data and Safety Plates

Operator Safety Warning Decal



The operator's warning decal describes basic instructions for safe operation of a lift truck. Read and understand these instructions and the other safety messages in this manual and on the truck.

- DO NOT OPERATE THIS VEHICLE UNLESS YOU ARE TRAINED AND AUTHORIZED. READ AND UNDERSTAND THE OPERATOR'S MANUAL BEFORE STARTING VEHICLE.
- DO NOT OPERATE DAMAGED OR FAULTY VEHICLE. DO NOT ATTEMPT REPAIRS UNLESS YOU ARE TRAINED AND AUTHORIZED.
- WHEN OPERATING IN MANUAL MODE, KEEP HANDS ON DESIGNATED GRIPS AND FEET AWAY FROM TRUCK. DO NOT OPERATE TRUCK WITH WET OR GREASY HANDS OR SHOES.
- WHEN OPERATING IN MANUAL MODE, BE VERY CAREFUL WHEN MANEUVERING IN CONFINED AREAS TO AVOID BEING PINNED.
- DO NOT LOAD VEHICLE OVER CAPACITY ON NAME-PLATE. DO NOT HANDLE UNSTEADY LOADS.

Know Your Truck Safety and Warning Decals

⚠ WARNING
DISCONNECT BATTERY BEFORE
HANDLING ELECTRICAL COMPONENTS. POLARITY MUST BE COR-
RECT TO PREVENT DAMAGE.

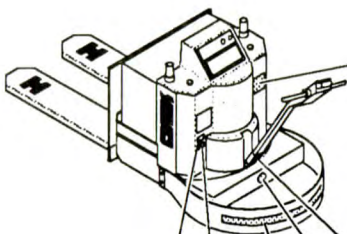
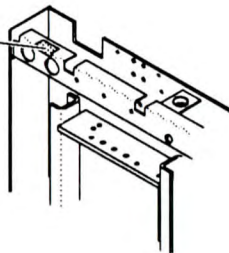

**NO
RIDING**

IMPORTANT
DO NOT CLEAN ELECTRICAL
COMPONENTS WITH SOLVENT
OR STEAM



IMPORTANT
FOR BATTERY SPECIFICATIONS
AND PROPER RESTRAINING IN-
FORMATION, SEE TRUCK PACKET
OR OPERATOR'S MANUAL.



CAUTION - AUTOMATIC VEHICLE

Know Your Truck Operator's Manual Controls

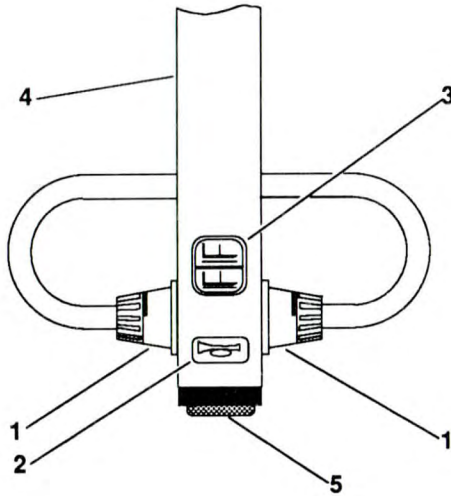

1. Forward / Reverse Control Levers
2. Horn Button
3. Lift / Lower Control Button
4. Manual Control Handle
5. Safety Cut-off Switch

Know Your Truck Autoguide Control Panel

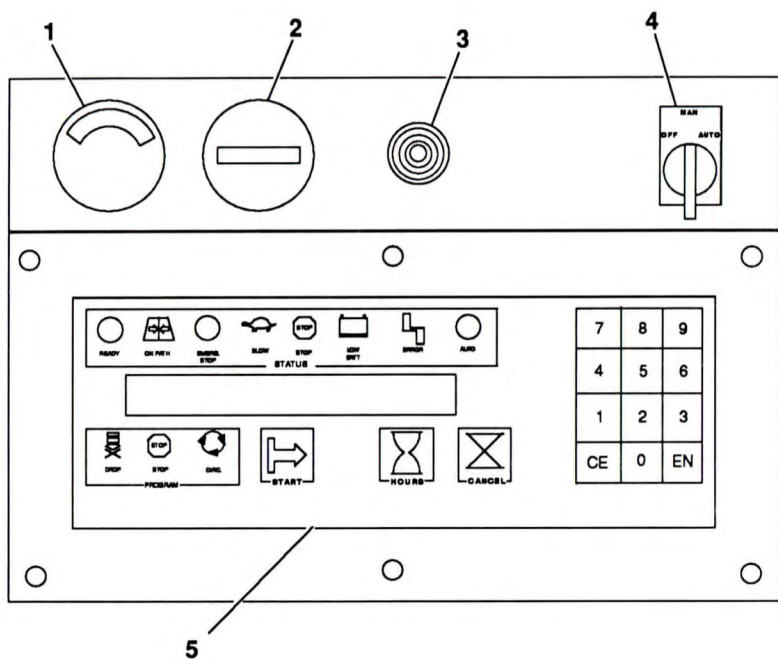

1. Battery Discharge Indicator (optional)
2. Hour Meter (optional)
3. Horn
4. Control Selector Switch
5. Computer Console

Know Your Truck Computer Console



- | | |
|--|--|
| <ol style="list-style-type: none"> 1. Ready Indicator 2. On Path Indicator 3. Emergency Stop Indicator 4. Slow Speed Indicator | <ol style="list-style-type: none"> 5. Stop Indicator 6. Low Battery Indicator 7. Error Indicator 8. Auto Control Indicator |
|--|--|

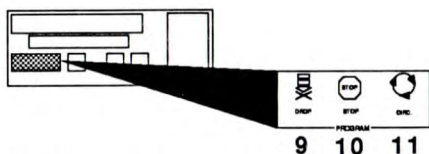

9. Drop 10. Stop 11. Circulate

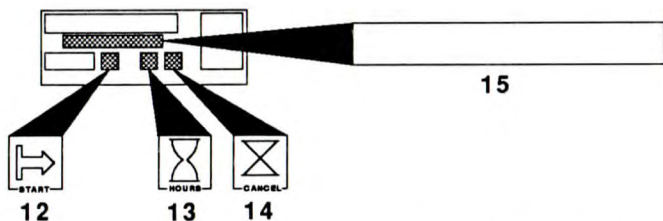

12. Start 13. Time 14. Cancel 15. LCD Indicator Display

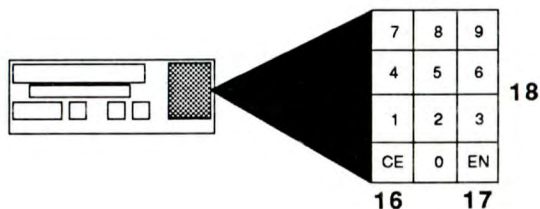

16. Clear Entry Key
17. Entry Key
18. Numeric Key Pad

4 Operator Care and Maintenance Index

Dally Safety Inspection 4.2

NOTICE:

The Occupational Safety and Health Act (OSHA) requires that the user examine his trucks before each shift to be sure they are in safe working order. Defects when found shall be immediately reported and corrected. The truck shall be taken out of service until it has been restored to safe operating condition.

Operator Care and Maintenance

Daily Safety Inspection

Before using a lift truck, it is the operator's responsibility to check its condition and be sure it is safe to operate.

Check for damage and maintenance problems, and have repairs made before you operate the truck. Unusual noises or problems should be reported immediately to the user's supervisor or other designated authority.

Do not make repairs yourself unless you have been trained in lift truck repair procedures and authorized by your employer. Have a qualified mechanic correct all discrepancies using genuine Clark or Clark approved parts.

Do not operate a truck if it is in need of repair. If it is in an unsafe condition, turn the switch to OFF, unplug the battery, and report the condition to the proper authority. If the truck becomes unsafe in any way while you are operating it, STOP operating the truck and report the problem immediately and have it corrected.

Lift trucks should be inspected every 8 hours, or at the start of each shift. This daily inspection should include a visual check for leaks and any obvious damage which may have been caused by operation during the last shift. Check the forks for damage. Look for loose bolts and fittings. Check the tires, wheels and wheel mounting bolts. Check the hydraulic reservoir oil level. Check all of the controls. Operate the truck briefly to be sure that all systems are performing correctly, and that all instruments, warning lights and the horn are functioning.

As an aid in carrying out this inspection, CLARK has prepared a form called "Driver's Daily Checklist". We recommend that you use this form to make a daily record of your inspections and truck condition.

Copies of this form may be obtained from your CLARK dealer.

Operator Care and Maintenance

Daily Safety Inspection

HOW TO PERFORM THE DAILY SAFETY AND OPERATING CHECKS

Visual Checks

First, perform a visual inspection of the truck and its major components. Walk around your lift truck and take note of obvious damage which may have been caused by operation during the last shift.

Check that all capacity, safety, and warning plates or decals are attached and legible.

Check that battery is installed and secured in position correctly. Check battery connector for safe condition. Look for any external leakage around drive axle.

Check for hydraulic oil leaks and loose fittings. **WARNING -- DO NOT USE BARE HANDS TO CHECK.** Oil may be hot or under pressure.

Be sure that any other safety devices are in place, undamaged and attached securely.

Then, check all of the critical components that handle or carry the load.

Check the brake interlock and lift limit switches.

Carefully inspect the load forks for cracks, breaks, bending, twists, and wear.

Inspect the wheels and tires for safe mounting and wear condition.

Check fluid levels.

Functional Checks

Test warning devices, horn, lights, and other safety equipment and accessories.

Turn switch on, be sure all controls and systems are performing correctly. Check the hour-meter. Operate the service brake, and hydraulic lift. Be sure all controls function freely.

Operator Care and Maintenance Daily Safety Inspection

Flashing Lights & Buzzer

Place AGV on guide-path and observe flashing lights and buzzer when machine is in automatic operation.

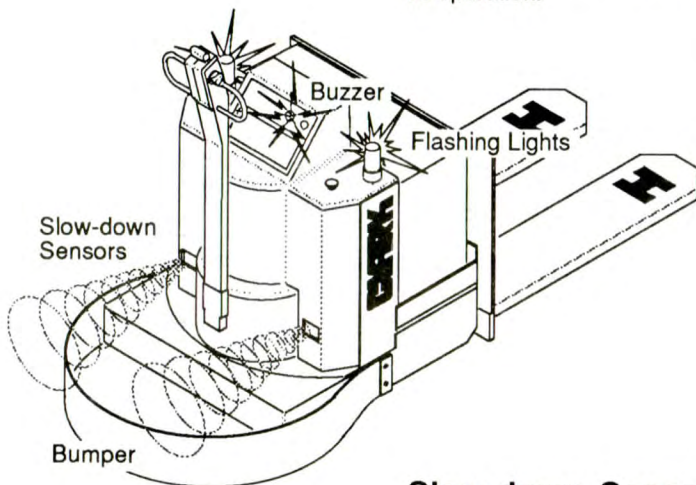

Bumper

The bumper is a safety device for forward travel.

When compressed, a micro-switch behind the bumper is triggered, causing the vehicle to come to a complete halt.

Once the bumper is released, the unit will again continue its course.

▲ WARNING:

Five seconds is allowed to stand clear of the vehicle. Failure to do so may result in injury as the unit attempts to continue on its course.

Slow-down Sensors

As an object penetrates the viewing field of the sensors, the vehicle will immediately slow down. (Range is approximately 8 feet). A red light on the sensor will glow.

Once the obstruction is removed, the unit will accelerate to normal speed.

▲ WARNING:

Do not stand in front of vehicle when checking this safety feature. Personal injury could result. Use a board to activate sensors.

Operator Care and Maintenance Daily Safety Inspection

WHEN FUNCTIONAL CHECKS ARE COMPLETED:

- Bring truck to a complete stop.
- Turn the switch to the OFF position.
- Lower the forks fully to the floor.

Standard Shut Down Procedure:

When parking and leaving truck unattended, forks should be fully lowered, brake set, and key removed (if equipped). Block the wheels if truck has possibility of moving.

Make a record on the "Driver's Daily Checklist" of all the operating and truck problems that you find. Review the check list to be sure it has been completed and turn it in to the person responsible for lift truck maintenance. Be sure any unusual noises or problems are investigated immediately.

Do not operate a lift truck that has a maintenance problem, or is not safe to operate.

Turn the switch to OFF, unplug the battery and put an "Out of Service" tag on the truck.



Be sure to put this operator's manual back in the holder. Read the manual again if you are not sure of all lift truck operating procedures.



If all of the "Before Operation" checks were normal or satisfactory, the truck can be operated.

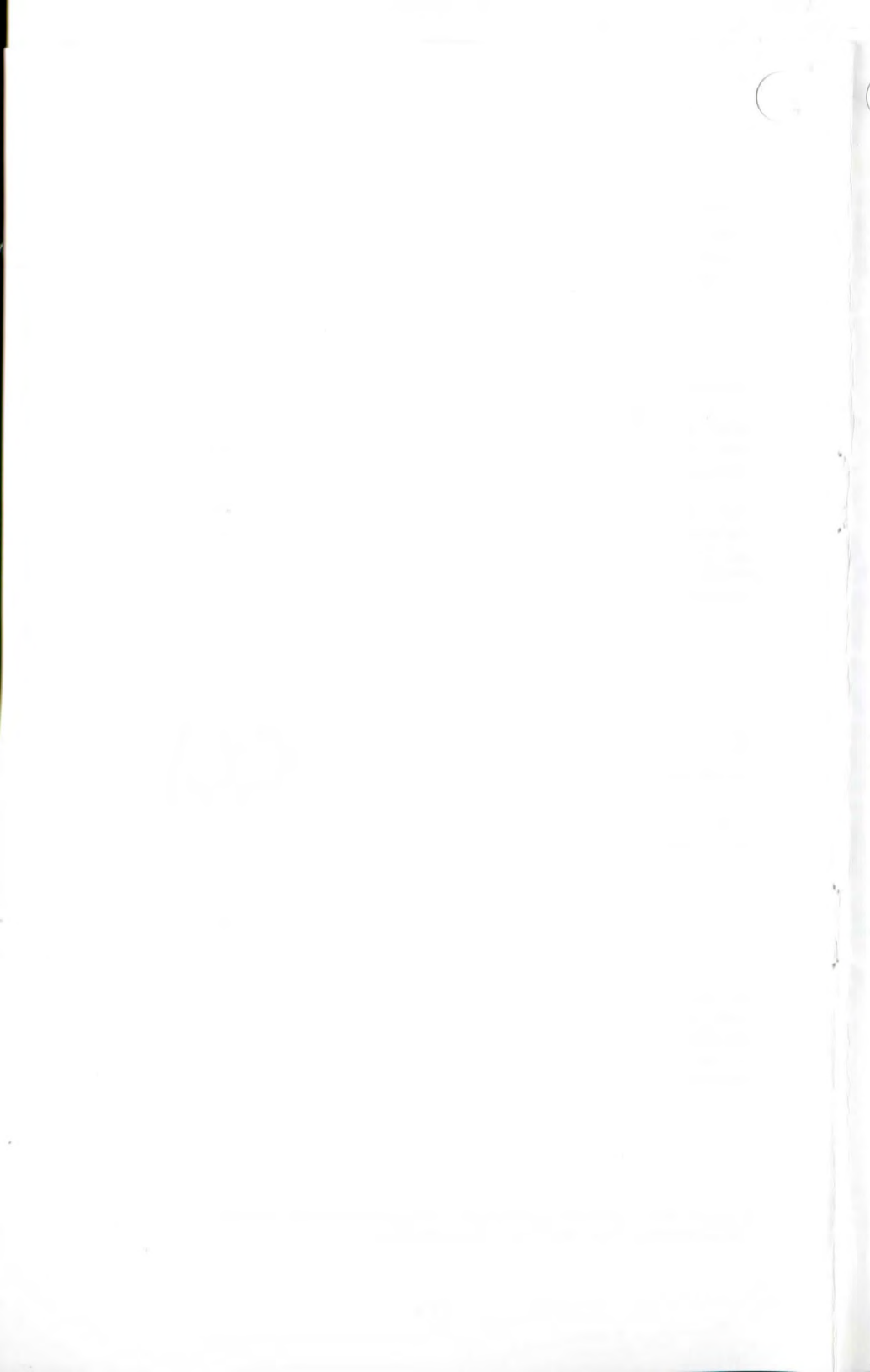

5 Operating Procedures Index

Before Operation 5.2

How to Operate Your Truck - Manual 5.3

After Operation - Manual 5.6

Computer Console 5.7

Operating Procedures Before Operation

Inspect your lift truck before operating at the start of the day or shift. Before putting your truck to use, check the operation of the controls and all systems.

Before operating a lift truck, check to see that:

1. Forks are fully lowered to the floor.
2. You are familiar with how all the controls function.
3. All controls are in neutral or other correct position.
4. Truck has been checked and is ready to operate.

Before using a lift truck, the operator must check the truck and complete the "Driver's Daily Checklist".

DO NOT OPERATE THE TRUCK, ANY OF ITS FUNCTIONS, OR ATTACHMENTS, FROM ANY PLACE OTHER THAN DESIGNATED OPERATOR'S POSITION.

Be sure to read and understand the information in the Operator's Manual before operating a lift truck.

The Operator's Manual is designed to be attached to the truck and stored in the provided pouch on the unit. It is placed there for ready reference by the operator. Refer to it often whenever you have questions about an operating procedure.

NOTICE

**THIS EQUIPMENT CAN BE DANGEROUS IF NOT USED PROPERLY.
SAFE OPERATION IS THE RESPONSIBILITY OF THE OPERATOR.**

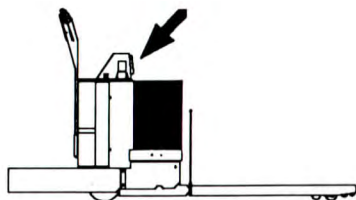

Operating Procedures

How to Operate Your Truck - Manual

Traveling

Observe all traffic regulations including authorized plant speed limits. Under normal traffic conditions, keep to the right. Maintain a safe distance, based on speed of travel, from the truck ahead and keep the truck under control at all times.

Yield the right of way to pedestrians, ambulances, fire trucks, or other vehicles in emergency situations.

Do not pass another truck traveling in the same direction at intersections, blind spots, or at other dangerous locations.

Slow down and sound horn at cross aisles and other locations where vision is obstructed. If the load being carried obstructs forward view, be sure pathway ahead is clear of personnel and objects before proceeding. Use extreme caution.

Keep a clear view of the path of travel and be alert for other traffic, personnel and safe clearances.

These trucks are designed for level floor operation. If it is necessary to operate them on a slight grade, ramp, or incline be sure to do so slowly and cautiously. Operators should be totally familiar with the controls, the braking action of the trucks, plugging techniques, etc. It is also recommended that the truck be operated at somewhat less than full capacity on grades, ramps and inclines to assure full braking traction.

Loaded trucks should be operated on all grades with load downgrade and forks fully lifted, ascending or descending.

Use extra caution when operating on grades. Never turn on any grade, ramp, or incline; always travel straight up and down.

Under all travel conditions the truck shall be operated at a speed that will permit it to be brought to a stop in a safe manner.

Make starts, stops, turns, or direction reversals in a smooth manner so as not to shift load and/or overturn the truck.

Do not indulge in stunt driving or horseplay.

Slow down on wet and slippery floors.

Before driving over a dockboard or bridgeplate, be sure that it is properly secured. Drive carefully and slowly across the dockboard or bridgeplate and never exceed its rated capacity.

Operating Procedures

How To Operate Your Truck - Manual

Do not drive trucks onto any elevator unless specifically authorized to do so. Approach elevators slowly, and then enter squarely after the elevator car is properly leveled. Once on the elevator, neutralize the controls, shut off power and set brakes. It is advisable that all other personnel leave the elevator before a truck is allowed to enter or leave.

Trucks shall enter elevator or other confined areas with load end forward.

Avoid running over loose objects on the roadway surface.

While negotiating turns, reduce speed, turning steering handle in a smooth sweeping motion. Except when maneuvering at a very low speed, turn handle at a moderate even rate.

Loading

Handle only stable and properly arranged loads. When handling loads which cannot be centered, operate with extra caution.

Handle only loads within the capacity of the truck as rated on the nameplate.

Use caution in handling long and wide loads. Stability and maneuverability may be adversely affected.

When attachments are used, extra care shall be taken in securing, manipulating, positioning and transporting the load. Operate trucks equipped with attachments as partially loaded trucks when not handling a load.

The handling of suspended loads, by means of a crane arm ("boom") or other device, can introduce dynamic forces affecting the stability of a truck that are not considered in the stability criteria. Sudden starts, stops and turns can cause the load to swing and create a hazard. The following precautions shall be taken when handling suspended loads:

Do not exceed the truck manufacturer's load rating of the trucks as equipped for handling suspended loads.

The load shall only be lifted vertically and never dragged horizontally.

The load shall be transported with the bottom of the load and the mast as low as possible.

Maneuvering the truck with load elevated shall be done slowly and cautiously and only to the extent necessary to permit lowering to the transport position.

Operating Procedures

How to Operate Your Truck - Manual

TRAVEL

Your truck can be operated while walking forwards or backwards.

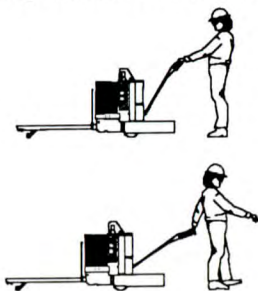

Turn the Control Selector Switch to the "MAN" position.

Pull the Manual Control Handle down, the brake will release.

Turn the handle to the desired direction of travel.

Look in all directions to make sure that your path of travel is clear.

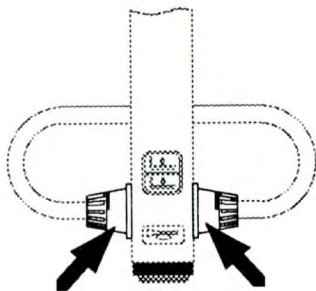

Slowly rotate Forward/Reverse Control Levers in the direction you want to travel.

Travel speed can be increased if your path of travel is clear.

Push the Manual Control Handle up to activate truck brake and stop truck travel. Brake also activates when handle is pushed totally down.

LIFT and LOWER

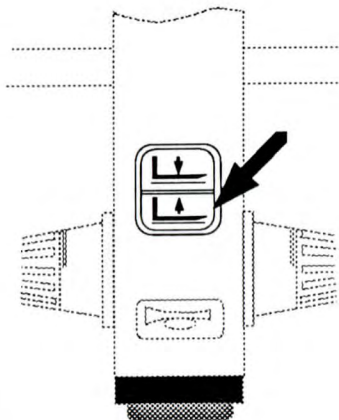

LIFT - Press "lift" button.

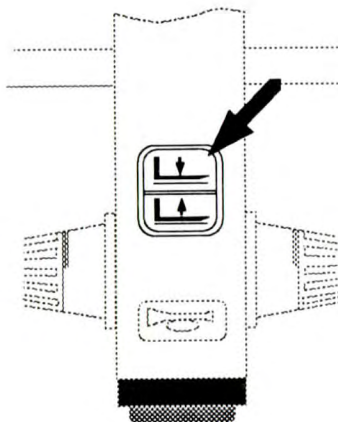

LOWER - Press "lower" button.

Operating Procedures After Operation - Manual

When finished using your truck...

Always leave your lift truck in a safe condition...

When you leave your truck or park it, follow these safety rules:

Park in a safe area away from normal traffic.

Never park on a grade.

Never park in areas which block emergency routes or equipment, or access to fire aisles, stairways, and fire equipment.

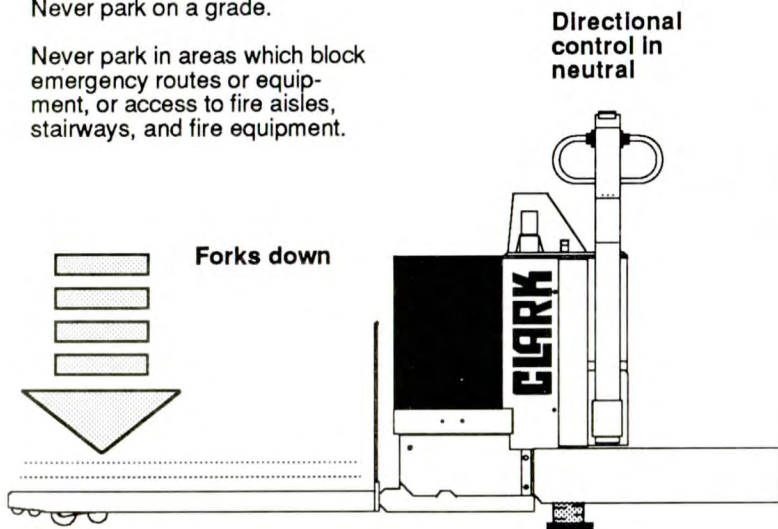

Before leaving the operator's position...

1. Stop the truck.
2. Lower the forks.
3. Make sure directional controls are in neutral.
4. Turn key switch to "off" position and remove key.
5. Block the wheels if the truck must be left on an incline or you have any doubt about the truck moving from a safe position.

Operating Procedures Computer Console

GENERAL PROGRAMMING

Before programming, the truck must be stopped and READY indicator on.

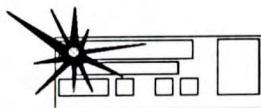

Before programming the Control Selector Switch must be set on MAN.

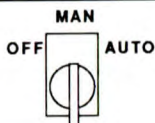

Chose a function you want the truck to do.

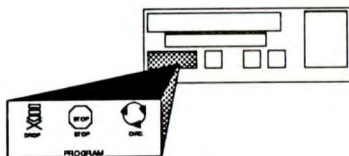

The last STOP or DROP station will be shown.

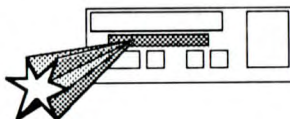

Enter station number and push the EN key. If ERROR is displayed on the LCD indicator, push CE and start again.

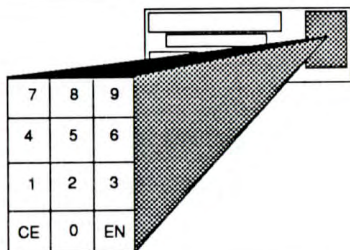

Push START.

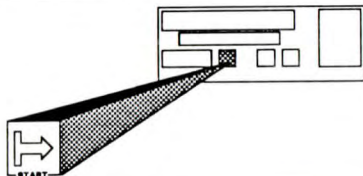

Turn Control Selector Switch to AUTO. There will be a 5 second audible warning, then truck will move.

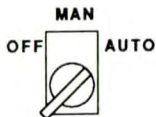

Operating Procedures Computer Console

DROP AND GO

Truck travels to the defined station stops, drops load and continues to the defined stop station.

TO PROGRAM - Truck must be stopped and the READY indicator on.

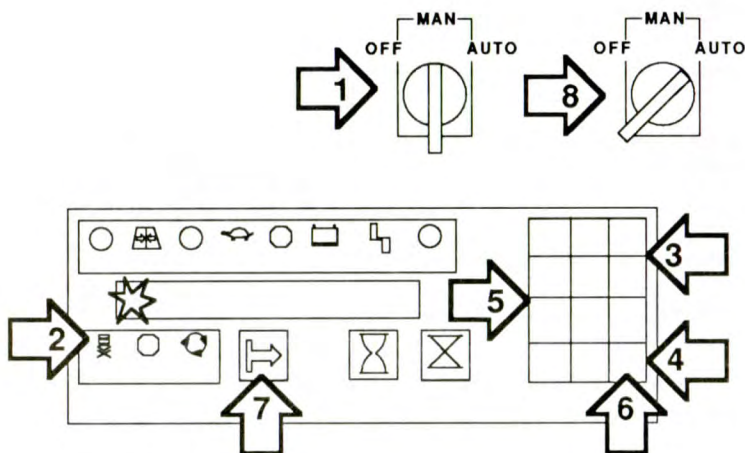

1. Turn switch to MAN.
2. Push DROP.
- ★ Last drop station is shown. If station number is OK skip step 3.
3. Enter new drop station number.
4. Push EN (enter).
- ★ Prompt for stop station number.
5. Enter stop station number.
6. Push EN (enter).
7. Push START.
8. Turn switch to AUTO.

Truck warning lights will flash. There will be a 5 second audible warning, then truck will move.

Operating Procedures Computer Console

DROP AND STOP

Truck travels to the defined station stops, drops load, moves away from load, and stops.

TO PROGRAM - Truck must be stopped and the READY indicator on.

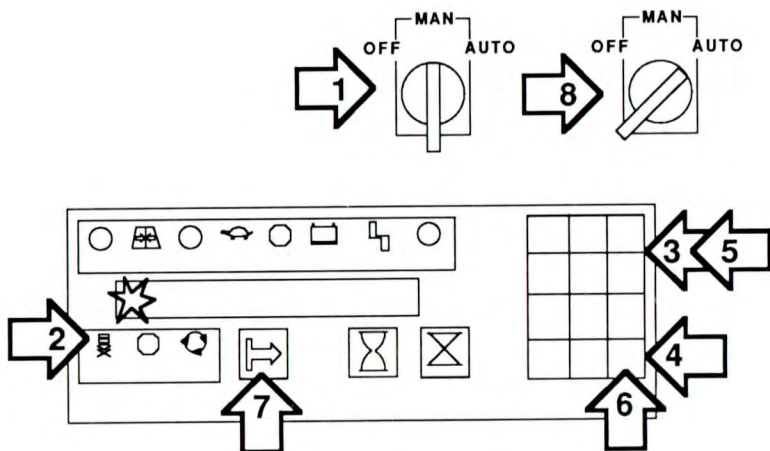

1. Turn switch to MAN.
2. Push DROP.
- ★ Last drop station is shown. If station number is OK, skip step 3.
3. Enter new drop station number.
4. Push EN (enter).
- ★ Prompt for stop station number.
5. Enter stop station number (same as drop station number).
6. Push EN (enter).
7. Push START.
8. Turn switch to AUTO.

Truck warning lights will flash. There will be a 5 second audible warning, then truck will move.

Operating Procedures Computer Console

GO TO STOP

Truck travels to the defined station stops. If it is loaded, it will not be unloaded.

TO PROGRAM - Truck must be stopped and the **READY** indicator on.

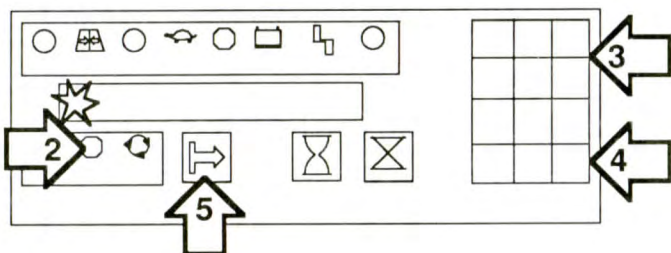
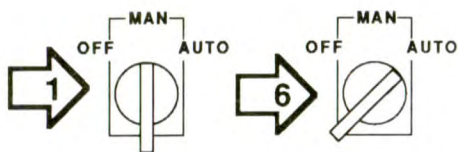

1. Turn switch to MAN.
2. Override drop prompt. Push STOP.

★ Last stop station is shown. If station number is OK, skip step 3.

3. Enter new stop station number.
4. Push EN (enter).
5. Push START.
6. Turn switch to AUTO.

Truck warning lights will flash. There will be a 5 second audible warning, then truck will move.

Operating Procedures Computer Console

DROP AND CIRCULATE

Truck travels to the defined station stops, drops load and continues on the defined circulation path until manually stopped for new orders.

TO PROGRAM - Truck must be stopped and the READY indicator on.

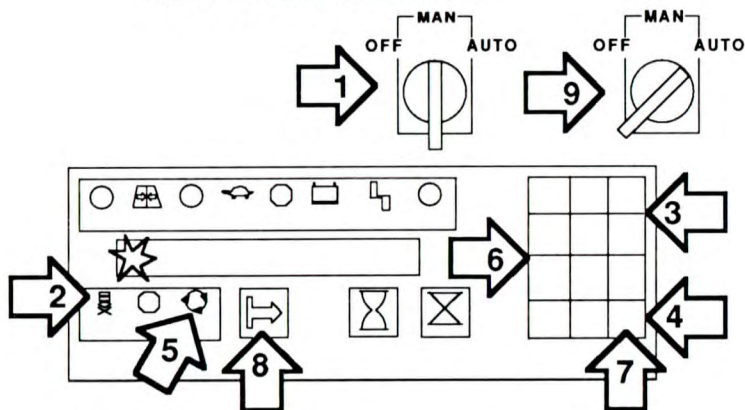

1. Turn switch to MAN.
2. Push DROP.
- ★ Last drop station is shown. If station number is OK skip step 3.
3. Enter new drop station number.
4. Push EN (enter).
- ★ Prompt for stop station number.
5. Override stop prompt. Push CIRCULATE.
- ★ Last circulation path is shown. If circulation path is OK skip step 6.
6. Enter new circulation path number.
7. Push EN (enter).
8. Push START.
9. Turn switch to AUTO.

Truck warning lights will flash. There will be a 5 second audible warning, then truck will move.

Operating Procedures Computer Console

CIRCULATE

Truck travels on the defined circulation path until manually stopped for new orders.

TO PROGRAM - Truck must be stopped and the READY indicator on.

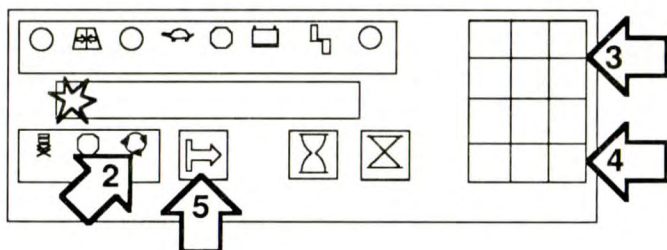
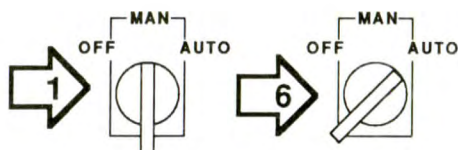

1. Turn switch to MAN.
2. Override drop and stop prompt. Push CIRCULATE.
- ★ Last circulation path is shown. If circulation path is OK, skip step 3.
3. Enter new circulation path number.
4. Push EN (enter).
5. Push START.
6. Turn switch to AUTO.

Truck warning lights will flash. There will be a 5 second audible warning, then truck will move.

Operating Procedures Computer Console

DIAGNOSTICS

TO PROGRAM - Truck must be stopped and the **READY** indicator on. Control Selector Switch must be on "MAN".

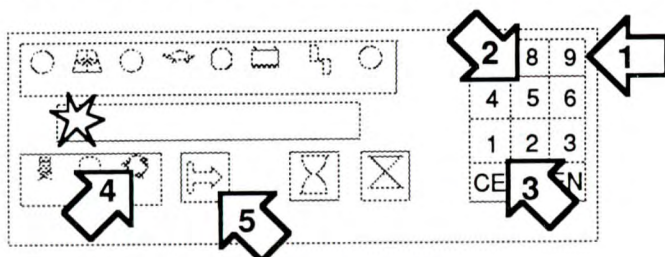

TO START DIAGNOSTIC MODE:

1. Push "9".
 2. Push "5".
 3. Push "1".
- ★ Diagnostic mode will be displayed.

TO USE DIAGNOSTIC MODE:

4. Push CIRCULATE to see previous display.
5. Push START to see next display.

★ DISPLAY

POS: xx	ERROR: xxx
ERR: xxxxxxxxxxxxxxxx	
FOLLOWING: Fx	
DESIRED FREQ: Fx	
FREQ: Fx Fy Fz	
POINT: xxx	
LAST RECEIVED: xxx	
STOP TIME: xxx SEC	
MAX SPEED: xxx f/m	
DL SPEED: xxx f/m	
CREEP SPEED: xxx f/m	
DROP MOVE: xx SEC	
LAYOUT: xx dd yyyy	
DEF SOFTW VERS: x.x	
TERM SOFTW VERS: x.x	

DEFINITION

Shows last detected errors ("0" = no error).
Errors present ("0" = no error; "1" = error).
What frequency is currently being followed.
Desired frequency.
What frequencies currently exist.
Last detected point number.
Last received character on serial link.
Number of seconds for time delayed stop.
Maximum speed (ft/min).
Dog-leash speed (ft/min).
Creep speed for drop (ft/min).
Time for creep speed at drop.
Date of layout definition.
Layout definition software version number.
Terminal software version number.

Operating Procedures Computer Console

DIAGNOSTICS

ERROR DEFINITION

0	No errors.	19	Forks did not lift.
1-15	Chopper errors.	20	Forks did not lower.
16	No (or bad) contact with chopper computer.	21	Forks did not stay up.
17	Not moving when it should be.	22	Loss of guide-wire when in AUTO.
18	Bad point number detected.	23	Desired frequency lost.

POS:08 ERROR:20

- ★ The POS / ERR display is capable of listing the last sixteen detected errors. In the above example, eight errors have occurred. "20" corresponds to error #8 and indicates forks did not lower (see ERROR DEFINITION above).

To view existing errors and correlating definitions:

1. Push DROP to move back in error list.
2. Push STOP to move forward in list.

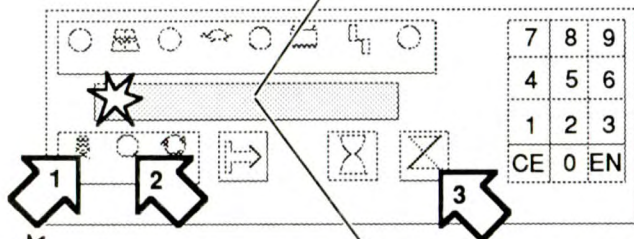

- ★ Each time a new error is detected, its number is placed on top of the list. The older errors move down one step so any existing past sixteen disappear.

Normal running condition (no errors) would be read as:
POS: 00 ERROR: 00.

ERR: 0000000011111111

- ★ The second display of the diagnostic mode (see previous page on how to obtain), exhibits the allotted sixteen error spaces. "1" signifies errors; "0" indicates no errors.

3. Push CANCEL to stop diagnostic mode.

6 Emergency Towing & Lifting

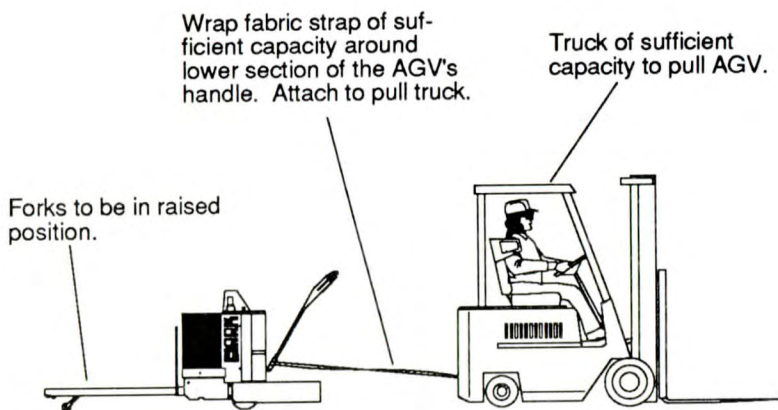

Note:

Bumper should be removed if any interference occurs.

Extract hinge-pins and pull off bumper.

Note:

If battery is removed or discharged, brake will automatically be applied.

To allow towing a truck under such circumstances, a 24 volt source (e.g. - two car batteries in series) can be connected to the battery cable. Disconnect wire 12C from 12B. Plug 12C into 28V.



Positioning of forks for lifting AGV.

If AGV is unstable, secure to forks before attempting to lift.

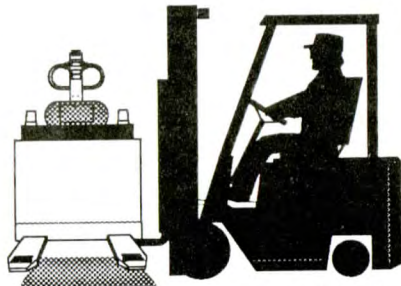

Use truck of sufficient capacity to lift AGV.

7 Maintenance Index

Periodic Maintenance Schedule 7.2

Lubrication Chart 7.3

Battery Maintenance 7.4

Maintenance

Periodic Maintenance

Daily

Charge, service and clean battery.

Inspect visually for damage or leakage.

Inspect load wheels for damage.

Inspect visually for loose or missing parts.

Check brake cut-off switch and service brake operation.

Check for smooth and proper functioning of all controls.

Weekly

Check level of hydraulic fluid with truck on level floor. Remove fill-plug. Hydraulic tank fluid level should be 1/2" from fill-plug hole. Add fluid as required (CLARK specification MS-68, part #885385).

Check drive unit fluid level. Remove fill-plug. Fluid level should be slightly below fill-plug hole. Add Dexron® II (CLARK part #879804) as required.

Check battery water level.

Equalize battery charge (See manufacturer's instructions).

Monthly

Service all grease fittings (see lubrication chart).

Apply chain lube to steering chain (CLARK part #886399).

Air-clean computer console assembly and chopper components.

Semi-Annually

Thoroughly scrub battery.

Thoroughly clean machine. Note: Absolutely NO water should contact the computer indicator panel or chopper boards.

Carefully inspect for loose or missing parts.

Inspect for wiring damage.

Check brake adjustment.

Service drive motor and pump motors.

Inspect tire and wheel.

Annually

Drain, flush and refill drive unit (see Lubrication chart).

Drain, flush and refill hydraulic reservoir (see lubrication chart).

Maintenance Lubricant Specifications

Lubricant	Specification	Application
General purpose grease for normal application.	Use grade NLGI #2 meeting CLARK specification MS-107B.	Steer control handle, vertical thrust bearing on top of drive unit, drive unit thrust rollers (4 rollers and fittings), all grease fittings (pivot pins, cylinder yoke pins, etc.) and trail wheel shafts.
Dexron® or Dexron® II automatic transmission fluid.	Dexron® or Dexron® II automatic transmission fluid (CLARK part #879804). Must pass requirements of pump wear test ASTM D-2882.	Drive unit.
Spline grease.	Use grade NLGI #2 (CLARK part number 1800531).	Axle shaft and motor-to-pump drive tang at overhaul.
Hydraulic fluid for normal application.	Must meet CLARK specification MS-68 (CLARK part number 885385).	Hydraulic sump tank.
Chain lube.	(CLARK part number 886399).	Steer-system chain

Maintenance Battery Maintenance

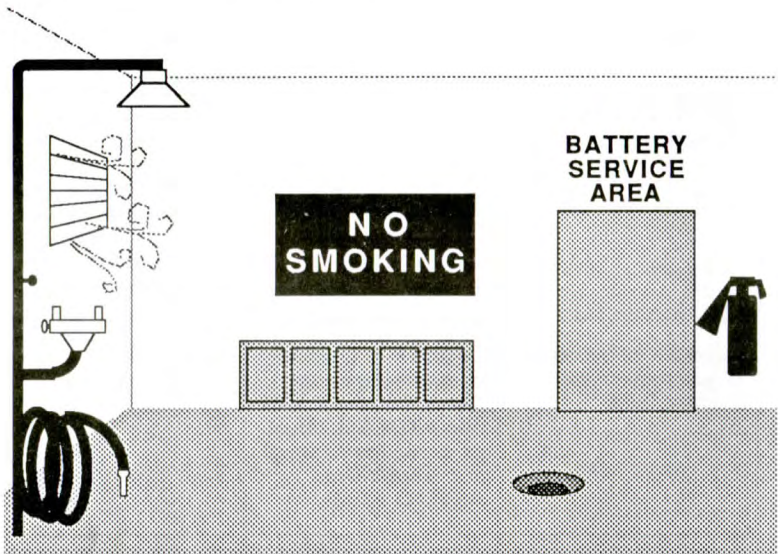

Battery charging installations must be located in areas designated for that purpose. These areas must be kept free of all non-essential combustible materials.

Facilities must be provided for:

- flushing spilled electrolyte
- fire protection
- protecting charging apparatus from damage by trucks
- adequate ventilation for dispersal of fumes from gas-gassing batteries

When handling acid concentrates greater than 50 percent acid (above 1.400 specific gravity), an eye wash fountain must be provided.

A conveyor, overhead hoist, or equivalent material handling equipment must be provided for handling batteries.

Changing and Charging Electric Truck Storage Batteries

IMPORTANT

Electric truck batteries are heavy and awkward to handle. They are filled with a very hazardous chemical solution. On charge, they give off hydrogen and oxygen which, in certain concentrations, are explosive. And they are costly. Before you remove, service, or install a truck battery, carefully read the following recommendations and instructions.

Maintenance

Battery Maintenance

Battery Handling

1. Change (remove) or service storage batteries only in an area designated for this purpose.
2. Be sure this area has provisions to flush and neutralize spillage, to ventilate fumes from gassing batteries, and for fire protection.
3. This area should be equipped with material-handling tools designed for removing and replacing batteries, including a conveyor or overhead hoist. Use lift hooks that have safety latches.
4. Always use a special lifting device such as an insulated spreader bar to attach the hoist to the battery. The width of the spreader bar hooks must be the same as the lifting eyes of the battery, to prevent damage to the battery. If the spreader bar hooks are movable, carefully adjust the position (width) of the hooks so that the pull is directly upward (vertical) and no side load or force (pressure) is exerted on the battery case. Be sure the lift hooks are the correct size to fit the lifting eyes of the battery.

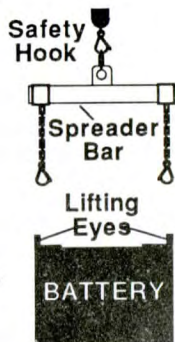

5. If the battery does not have a cover of its own or has exposed terminals and connectors, cover the top with a non-conductive (insulating) material, e.g., a sheet of plywood or heavy cardboard, prior to attaching the lifting device.

Non-conductive material

6. Chain hoists or power battery hoists must be equipped with load-chain containers to accumulate the excess lifting chain.

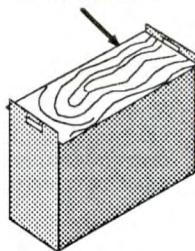

7. Keep all tools and other metallic objects away from the terminals.

WARNING

BATTERY SERVICE

BATTERY SERVICE MUST BE DONE BY TRAINED AND AUTHORIZED PERSONNEL. BATTERY ACID CAN CAUSE SEVERE BURNS AND INJURY.

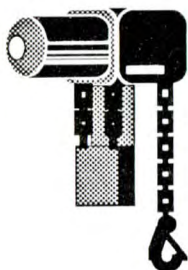

Maintenance

Battery Maintenance

Battery Charging

1. Persons maintaining storage batteries must wear protective clothing such as face shield, long sleeves, and gloves.



2. Hydrogen emissions from charging batteries are flammable. No smoking shall be allowed in the charging area. Do not check the electrolyte level with an open flame. Do not allow open flame, sparks or electric arcs in battery charging area.

WARNING SULFURIC ACID

THE BATTERY CONTAINS CORROSIVE ACID WHICH CAN CAUSE INJURY. IF ACID CONTACTS YOUR EYES OR SKIN, FLUSH IMMEDIATELY WITH WATER AND GET MEDICAL ASSISTANCE.

WARNING EXPLOSIVE GASES

DO NOT SMOKE OR HAVE OPEN FLAMES OR SPARKS IN BATTERY CHARGING AREAS OR NEAR BATTERIES. AN EXPLOSION CAN CAUSE INJURY OR DEATH.

3. When charging batteries, the vent caps must be kept in place to avoid electrolyte spray. Care must be taken to assure that vent caps are open (clean) and functioning. The battery (or compartment) cover(s) must be open to dissipate heat and gas.

IMPORTANT

If batteries discharge rapidly during normal operation or do not charge to the correct specifications, contact a qualified battery service technician to check the battery for you. **DO NOT ADD ELECTROLYTE OR ATTEMPT TO SERVICE THE BATTERY.**

Maintenance

Battery Maintenance

Battery Removal From Truck

1. Check the designated service and charging area for fire protection, and be sure all sources of ignition are cleared from the area. **DO NOT SMOKE.** Be sure all previous noted equipment is in the area, in good repair, and working properly.

If the battery is to be serviced, be sure there are provisions to flush and neutralize spillage and to disperse (ventilate) fumes from gassing batteries on charge. Be sure there are provisions for handling electrolyte.

2. Before attempting to remove or charge a storage battery, the truck should be positioned in the designated battery service area and the brake applied so the truck cannot move.

3. If the battery is not equipped with its own cover, cover the battery when handling, with a non-conductive (insulating) material, e.g., plywood or heavy cardboard, before attaching the lifting device. Also see "Battery Handling"

4. Use an approved lifting device with an insulated spreader bar, to remove and transport a truck battery. Hoist and lifting chains must be equipped with safety hooks.

5. Remove the battery and place it in a safe storage location. Store batteries either on an approved battery rack or on a wooden pallet.

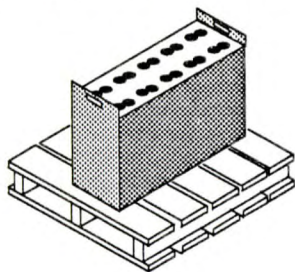

Battery Cleaning

NEVER WASH THE BATTERY WHEN IT IS IN THE TRUCK.

The easiest and most satisfactory method of cleaning a battery is to wash it occasionally with a low pressure cold water spray. The top can also be washed off with a solution of baking soda and water (add a box of baking soda to a pail of water and stir until dissolved) and rinsed with clean water. It is good practice to have this solution available around a battery room at all times.

IMPORTANT

During cleaning, **THE BATTERY VENT CAPS MUST BE TIGHTLY IN PLACE.**

Battery Care and Maintenance

Refer to the **BATTERY MANUFACTURER** or **SUPPLIER** for their recommended procedures.

BATTERY SAVER and **CLEANER**, Clark Part No. 886398, may be used to clean and protect the truck battery.

New Truck Batteries:

Spray a light coat of **BATTERY SAVER** and **CLEANER** over the entire surface of the battery. Do not wipe off.

Old Truck Batteries:

Apply a light coat of **BATTERY SAVER** and **CLEANER** to entire surface of battery. Allow to set for approximately 30 seconds, then wipe thoroughly with a wiping cloth or rag. Chemical action will dissolve rust and corrosion. After cleaning, apply a second coating for protection. This will prevent the start and growth of corrosion on battery terminals and cable connections.

Maintenance

Battery Maintenance

Battery Service Records

A record of battery service and maintenance should be kept to obtain the best service life from your battery and truck.

Select a pilot cell, take readings of specific gravity and temperature before and after charging, and make a record of readings with the date. It is best to change the location of the pilot cell occasionally to distribute any electrolyte loss over the battery when taking readings. Every 2 to 3 months, take complete battery readings (specific gravity, temperature and voltage) and make a record of them.

How To Get Maximum Life From Battery

1. Follow normal battery maintenance procedures, re-charging before 80% discharged and with periodic equalizing charges.

2. Don't add acid to a battery. Only a person trained and qualified to do battery maintenance should determine if this is necessary.

3. Lift battery only with a correctly constructed lifting device which will not put pressure on the battery case.

4. Keep open flames, tools, and metal objects away from the top of battery to prevent short circuits and explosions.

5. Check the battery electrolyte level before each charging. Add water if the top of the separator or plates are visible.

DO NOT OVERFILL!

6. Do not overcharge.

7. **KEEP BATTERY CLEAN AND DRY.** Wash down as needed.

Battery Installation

1. Use only a lead-acid battery with the voltage and ampere-hour rating specified for the truck.

2. When changing batteries on battery electric trucks, replacement batteries must be of the service weight that falls within the minimum/maximum range specified on truck nameplate.

3. Be sure truck is properly positioned and brake applied.

4. Handle battery only with approved lifting device.

5. Install the battery correctly in the truck and secure it in position.

NOTICE -- Some trucks are equipped with battery stops or blocks. Others do not require them. If the truck being serviced has battery stops or blocks, be sure none are missing or damaged. Replace them as necessary. If they are an adjustable type, be sure they are correctly adjusted and tightened.





Additional copies of this manual may be purchased from
YOUR AUTHORIZED CLARK DEALER

CLARK

333 West Vine Street
Lexington, KY 40507-1640

Printed in U.S.A.