

CLARK®



Operator's Manual

TMG 12-25

Book No. 2817441
OM-616

Do not remove this manual
from the truck.

Record the following information pertaining to your truck.

Model No. _____

Serial No. _____

Customer Truck Identification No. _____

Truck Weight, Empty _____

Truck Rated Capacity _____

Truck Gross Weight _____

Truck Gross Weight, Loaded w/ Rated Load _____

Special Equipment or Attachments _____

IMPORTANT

Do not expose this manual to hot water or steam.

Operator's Manual

You must be trained and authorized to operate a lift truck.

YOU can prevent accidents

First: Learn safe operating rules and your company rules.

Next: Read your Operator's Manual. If you do not understand it, ask your supervisor for help.

Learn about the unit you operate.



KNOW YOUR TRUCK

Then: Practice operating your truck safely.

And: Keep your truck in safe operating condition with correct and timely maintenance.

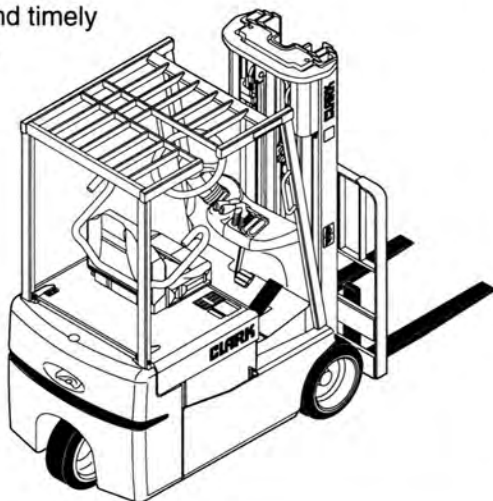

Breaking these rules will cause serious or fatal injury to yourself and others

A Message to CLARK Lift Truck Operators

Lift trucks are specialized machines with unique operating characteristics, designed to perform a specific job. Their function and operation is not like a car or ordinary truck. They require specific instructions and rules for safe operation and maintenance.

Safe operation of lift trucks is of primary importance to CLARK. Our experience with lift truck accidents has shown that when accidents happen and people are killed or injured, the causes are:

- **Operator not properly trained**
- **Operator not experienced with lift truck operation**
- **Basic safety rules not followed**
- **Lift truck not maintained in safe operating condition**

For these reasons, CLARK wants you to know about the safe operation and correct maintenance of your lift truck.

This manual is designed to help you operate your lift truck safely. This manual shows and tells you about safety inspections and the important general safety rules and hazards of lift truck operation. It describes the special components and features of the truck and explains their functions. The correct operating procedures are shown and explained. Illustrations and important safety messages are included for clear understanding. A Section on maintenance and lubrication is included for the lift truck mechanic.

The operator's manual is not a training manual. It is a guide to help trained and authorized operators safely operate their lift truck by emphasizing and illustrating the correct procedures. However, it cannot cover every possible situation that may result in an accident. You must watch for hazards in your work areas and avoid or correct them. It is important that you know and understand the information in this manual and that you know and follow your company safety rules! Be sure that your equipment is maintained in a safe condition. Do not operate a damaged or malfunctioning truck. Practice safe operation every time you use your lift truck. Let's join together to set high standards in safety.

Remember, before you start operating this lift truck, be sure you understand all driving procedures. It is your responsibility, and it is important to you and your family, to operate your lift truck safely and efficiently. Be aware that the Federal Occupational Safety and Health Act (OSHA) and state laws require that operators be completely trained in the safe operation of lift trucks; it is also an (OSHA) requirement that a machine inspection be performed before every shift. If you think you need training in operating or inspecting your lift truck, ask your supervisor.

CLARK lift trucks are built to take hard work, but not abuse. They are built to be dependable, but they are only as safe and efficient as the operator and the persons responsible for maintaining them. Do not make any repairs to this truck unless you have been trained in safe lift truck repair procedures and are authorized by your employer.

Contents of this Manual

This manual covers trucks with capacities from 2500lbs (1250 kg) through 5000lbs (2500 kg).

A Message to CLARK Lift Truck Operators	ii
Introduction	vi
How to Use this Manual	viii
Safety Signs and Safety Messages	x
Section 1. General Safety Rules	1-1
Section 2. Operating Hazards	2-1
Section 3. Know Your Truck	3-1
Section 4. Operator Maintenance and Care	4-1
Section 5. Starting and Operating Procedures	5-1
Section 6. Emergency Towing	6-1
Section 7. Planned Maintenance	7-1
Section 8. Specifications	8-1
Index	Index-1

Introduction

CLARK welcomes you to the growing group of professionals who own, operate, and maintain CLARK lift trucks. We take pride in the long tradition of quality products and superior value the CLARK name represents. This manual familiarizes you with safety, operating, and maintenance information about your new lift truck. It has been specially prepared to help you use and maintain your CLARK lift truck in a safe and correct manner.

Your CLARK lift truck has been designed and built to be as safe and efficient as today's technology can make it. As manufactured, it meets all the applicable mandatory requirements of ANSI B56.1-1988 Safety Standard for Powered Industrial Trucks. Each truck is also furnished with equipment to help you operate safely; for example, load back rest, parking brake and horn are standard equipment.

Safe, productive operation of a lift truck requires both skill and knowledge on the part of the operator. The operator must know, understand, and practice the safety rules and safe driving and load handling techniques described in this manual. To develop the skill required, the operator must become familiar with the construction and features of the lift truck and how they function. The operator must understand its capabilities and limitations, and see that it is kept in a safe condition.

Routine Servicing and Maintenance

Regular maintenance and care of your lift truck is not only important for economy and utilization reasons; it is essential for your safety. A faulty lift truck is a potential source of danger to the operator, and to other personnel working near it. As with all quality equipment, keep your lift truck in good operating condition by following the recommended schedule of maintenance.

Operator Daily Inspection — Safety and Operating Checks

A lift truck should always be examined by the operator, before driving, to be sure it is safe to operate. The importance of this procedure is emphasized in this manual with a brief illustrated review and later with more detailed instructions. CLARK dealers can supply copies of a helpful "Drivers Daily Checklist."

Planned Maintenance

In addition to the daily operator inspection, CLARK recommends that a planned maintenance and safety inspection program (PM) be performed by a trained and authorized mechanic on a regular basis. The PM will provide an opportunity to make a thorough inspection of the safety and operating condition of your lift truck. Necessary adjustments and repairs can be done during the PM, which will increase the life of components and reduce unscheduled downtime and increase safety. The PM can be scheduled to meet your particular application and lift truck usage.

The procedures for a periodic planned maintenance program that covers inspections, operational checks, cleaning, lubrication, and minor adjustments are outlined in this manual. Your CLARK dealer is prepared to help you with a Planned Maintenance Program by trained service personnel who know your lift truck and can keep it operating safely and efficiently.

Service Manual

In-depth service information for trained service personnel is found in *Service Manual SM616*

How to Use this Manual

This manual is a digest of essential information about the safe operation, the features and functions and explains how to maintain your lift truck. This manual is organized into eight major parts:

Section 1, General Safety Rules, reviews and illustrates accepted practices for safe operation of a lift truck.

Section 2, Operating Hazards, warns of conditions that could cause damage to the truck or injury to the operator or other personnel.

Section 3, Know Your Truck, describes the major operating components, systems, controls, and other features of your truck and tells how they function.

Section 4, Operator Maintenance and Care, presents details on how to perform the operator's daily safety inspection and refuel the lift truck.

Section 5, Starting and Operating Procedures, discusses specific instructions on the safe, efficient operation of your lift truck.

Section 6, Emergency Towing, gives instructions for towing your truck in an emergency.

Section 7, Planned Maintenance, describes the PM program.

Section 8, Specifications, provides reference information and data on features, components, and maintenance items.

Also, the **Index** helps you locate information about various topics.

NOTICE: The descriptions and specifications included in this manual were in effect at the time of printing. CLARK Material Handling Company reserves the right to make improvements and changes in specifications or design, without notice and without incurring obligation. Please check with your authorized CLARK dealer for information on possible updates or revisions.

The examples, illustrations, and explanations in this manual should help you improve your skill and knowledge as a professional lift truck operator and take full advantage of the capabilities and safety features of your new lift truck.

The first Section of the manual is devoted to a review, with illustrations and brief messages, of general safety rules and the major operating hazards you can encounter while operating a lift truck. Next, you will find descriptions of the components of your specific lift truck model and how the instruments, gauges, and controls operate. Then, you will find a discussion of safe and efficient operating procedures, followed by instructions on how to tow a disabled lift truck. The later sections of the manual are devoted to maintenance and truck specifications.

Take time to carefully read the "Know Your Truck" section. By acquiring a good basic understanding of your truck's features, and how they function, you are better prepared to operate it both efficiently and safely.

In "Planned Maintenance," you will find essential information for correct servicing and periodic maintenance of your truck, including charts with recommended maintenance intervals and component capacities. Carefully follow these instructions and procedures.

Each major Section has its own table of contents, so that you can find the various topics more easily. If you cannot find a topic in the table of contents, check the index at the back of the manual.

We urge you to first carefully read the manual from cover to cover. Take time to read and understand the information on general safety rules and operating hazards. Acquaint yourself with the various procedures in this manual. Understand how all gauges, indicator lights, and controls function. Please contact your authorized CLARK dealer for the answers to any questions you may have about your lift truck's features, operation, or manuals.

Operate your lift truck safely; careful driving is your responsibility. Drive defensively and think about the safety of people who are working nearby. Know your truck's capabilities and limitations. Follow all instructions in this manual, including all **IMPORTANT**, **CAUTION**, **WARNING**, and **DANGER** messages to avoid damage to your lift truck or the possibility of any harm to yourself or others.

This manual is intended to be a permanently attached part of your lift truck. Keep it on the truck as a ready reference for anyone who may drive or service it. If the truck you operate is not equipped with a manual, ask your supervisor to obtain one and have it attached to the truck. And, remember, your CLARK dealer is pleased to answer any questions about the operation and maintenance of your lift truck and will provide you with additional information should you require it.

Safety Signs and Safety Messages

Improper operation can cause accidents. Don't take chances with incorrect or damaged equipment. **Read** and **understand** the procedures for safe driving and maintenance outlined in this manual. Don't hesitate to ask for help. **Stay alert!** Follow safety rules, regulations, and procedures. Avoid accidents by recognizing dangerous procedures or situations before they occur. **Drive and work safely** and follow the safety signs and their messages on the truck and in this manual.

Safety signs and messages are placed in this manual and on the truck to provide instructions and identify specific areas where potential hazards exist and special precautions should be taken. Know and understand the meaning of these instructions, signs, and messages. Damage to the truck, death, or serious injury to you or other persons may result if these messages are not followed. If warning decals are damaged, they must be replaced. Contact your CLARK dealer for replacements.

NOTICE

This message is used when special information, instructions or identification are required relating to procedures, equipment, tools, pressures, capacities and other special data.

IMPORTANT

This message is used when special precautions should be taken to ensure a correct action or to avoid damage to or malfunction of the truck or a component.



CAUTION

This message is a reminder of safety practices that can result in personal injury if proper precautions are not taken.



WARNING

This message indicates a hazard exists that can result in injury or death if proper precautions are not taken.



DANGER

This message is used when an extreme hazard exists.

General Safety Rules

Contents

Daily Inspection	1-2
Do's and Don'ts	1-3
Seat Belts	1-4
No Riders	1-5
Pedestrians	1-6
Operator Protection	1-7
Fork Safety	1-8
Pinch Points	1-9
Travel	1-10
Grades, Ramps, Slopes, and Inclines	1-11
Tip Over	1-12
What To Do in Case of Tip Over	1-13
Surface and Capacity	1-14
Parking	1-15

Daily Inspection

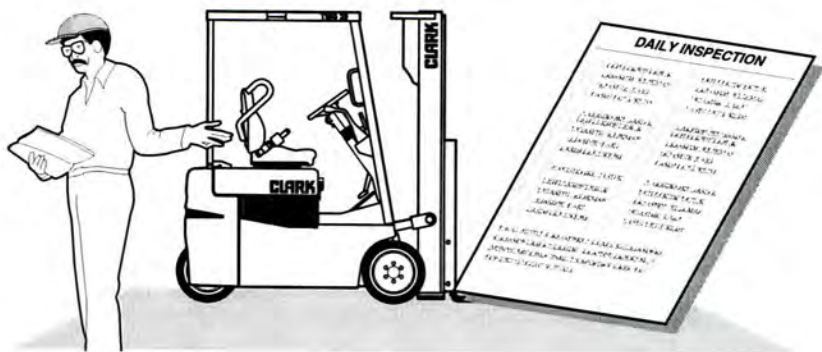

- At the beginning of each shift, inspect your truck and fill out a daily inspection sheet. This is an OSHA requirement.
- Check for damage and maintenance problems.
- Have repairs made before you operate the truck.
- Do not make repairs yourself. Lift truck mechanics are trained professionals. They know how to make repairs safely. (See Section 4)

Do's and Don'ts



Don't mix drugs or alcohol with your job.

Do watch for pedestrians.



Don't block safety or emergency equipment.

Do wear safety equipment when required.



Don't smoke in "NO SMOKING" areas or when refueling.

Seat Belts

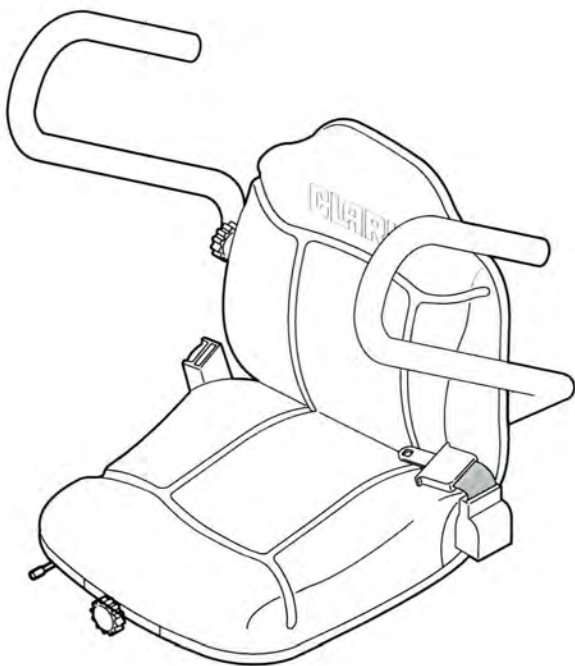

ALWAYS BUCKLE UP

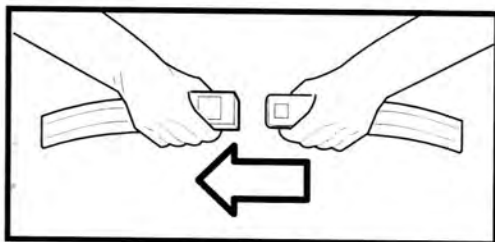

Seat belts can reduce injuries.

No Riders

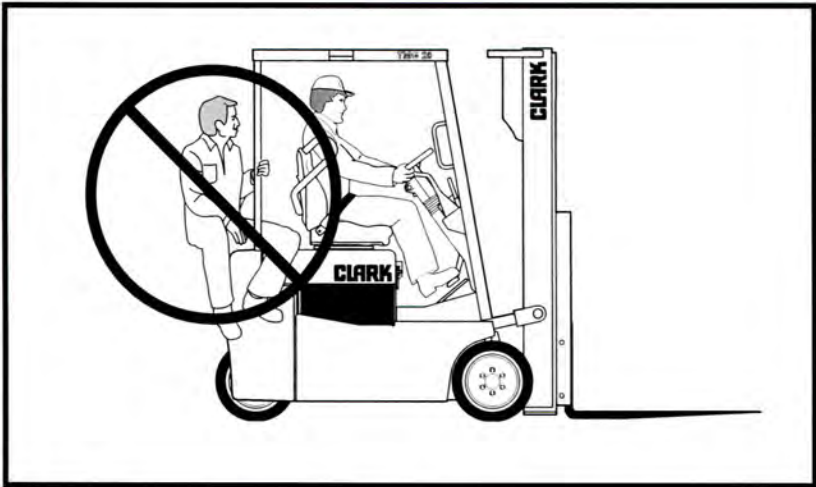

The operator is the only one who should be on a truck.

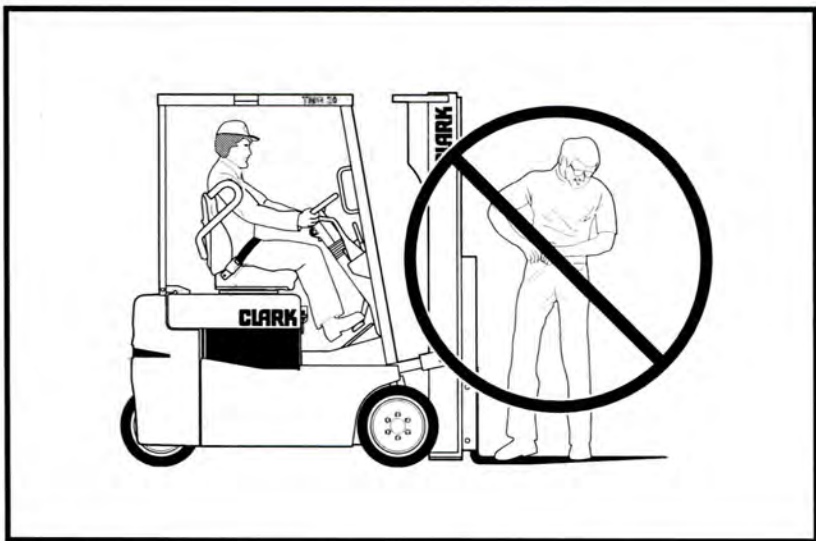

Never transport personnel on the forks of a lift truck.

Pedestrians

Watch where you are going. Look in the direction of travel. Pedestrians may use the same roadway you do. Sound your horn at all intersections or blind spots.

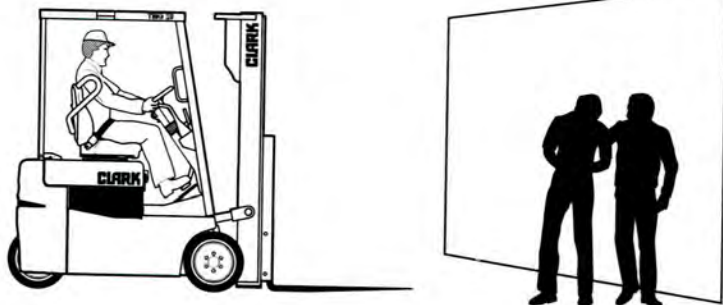
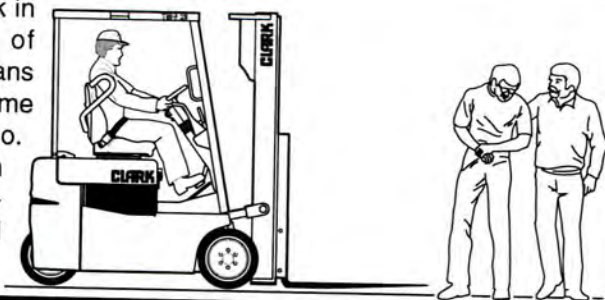

Watch for people in your work area even if your truck has warning lights or alarms. People may not watch for you. Let people know you are about to move if they are near your truck. Watch out for rear swing.

Make people stand back, even when you are parked.



Operator Protection

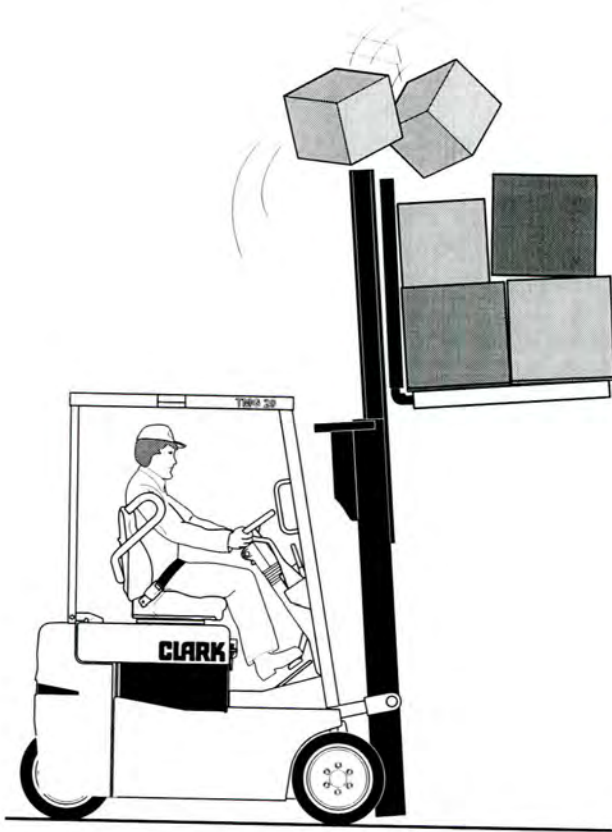

Keep under the overhead guard.
Always keep your body within the confines of the truck.

Fork Safety

Never allow anyone to walk under raised forks.



DANGER

There is special equipment to raise people for overhead work. **DO NOT USE LIFT TRUCKS.**

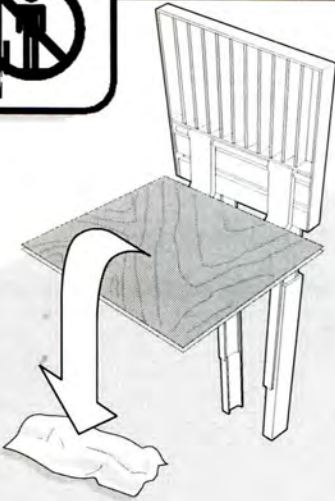

Pinch Points

! WARNING

Keep hands, feet and legs out of the upright.

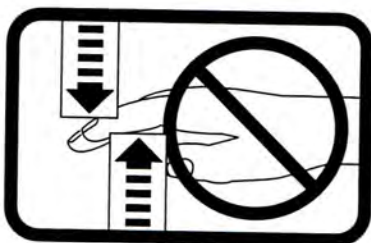

! WARNING

Don't use the upright as a ladder.



! CAUTION

Never try to repair the upright, carriage, chain, or attachment yourself! Always get a trained mechanic.



Travel

Travel with the load near the floor/ground with upright tilted back to cradle the load whenever possible.

Never lift or lower the load when the truck is in motion.

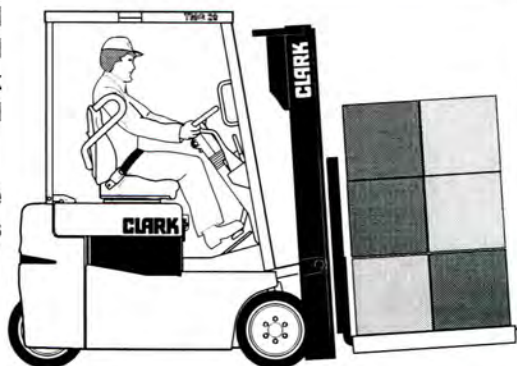

When handling bulky loads that restrict your vision operate your truck in reverse to improve visibility. Be sure to pivot in the seat to give maximum visibility.



Unstable loads are a hazard to you and to your fellow workers. Always make certain that the load is well stacked and evenly positioned across both forks. Never attempt to lift a load with only one fork.



Right

Wrong



Grades, Ramps, Slopes, and Inclines

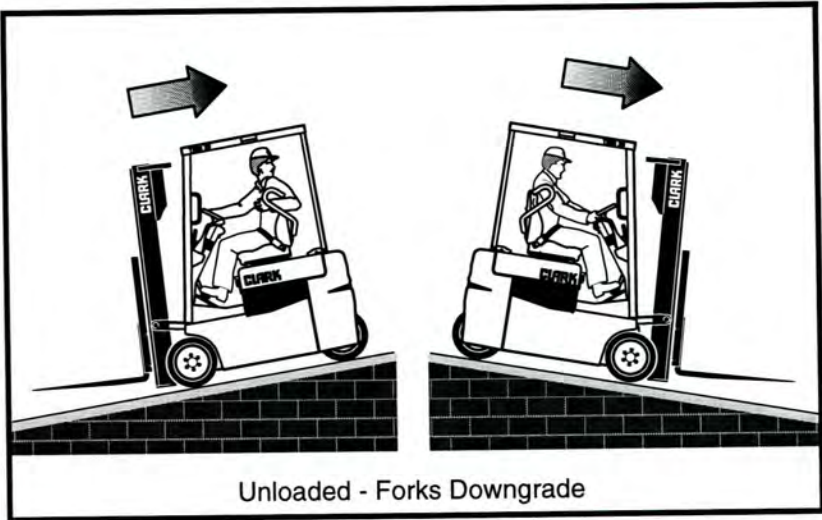

WARNING

Never turn on a grade, either loaded or unloaded.

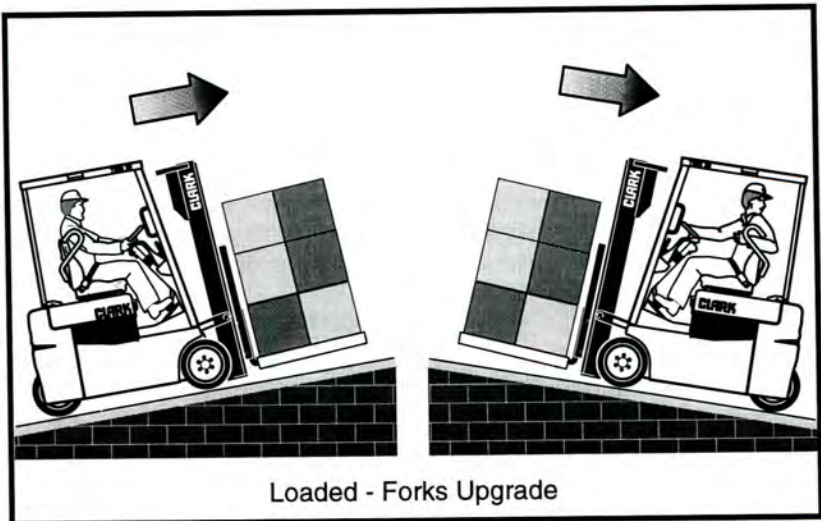

Tipover

Lateral Tip-over

- Lateral tip-over can occur with a combination of speed and sharpness of turn. This combination will exceed the stability of the truck. This condition is even more likely with an unloaded truck.
- With the load or upright raised, lateral tip-over can occur while turning and/or braking when traveling in reverse or accelerating and turning while traveling forward.
- Lateral tip-over can occur loaded or unloaded by turning on an incline or ramp.



Longitudinal Tip-over

- Longitudinal tip-over can occur with a combination of overloading and load elevated also with capacity load and elevated. This combination will exceed the stability of the truck. This condition is even more likely with excessive forward tilt, braking in forward travel or accelerating rearward.
- Longitudinal tip-over can occur by driving with the load down slope on a steep grade.

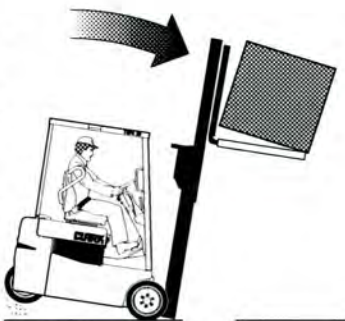

Lateral and longitudinal tip-over can occur if the truck is driven over objects on the floor or ground, off the edge of improved surfaces, or into potholes in the road surface, or by running into overhead objects or collisions.

An off dock type of tip-over can occur if the truck is steered too close to the dock edge, driven off the edge of the dock or ramp, or if the highway truck or trailer rolls away from the dock or is driven away during loading.



WARNING

The conditions listed above can be further aggravated by overloading, excessive tilt, or off center loads.



DANGER

Lift truck tip-over can cause serious injury or death if the operator is trapped between the truck and the ground.

What to do in Case of a Tip-over



WARNING

If your truck starts to tip over,

DO NOT JUMP!!!

Brace yourself as illustrated below!

1. Make sure your seat belt is fastened securely.
2. Stay in your seat.
3. Grip the wheel.
4. Brace your feet.

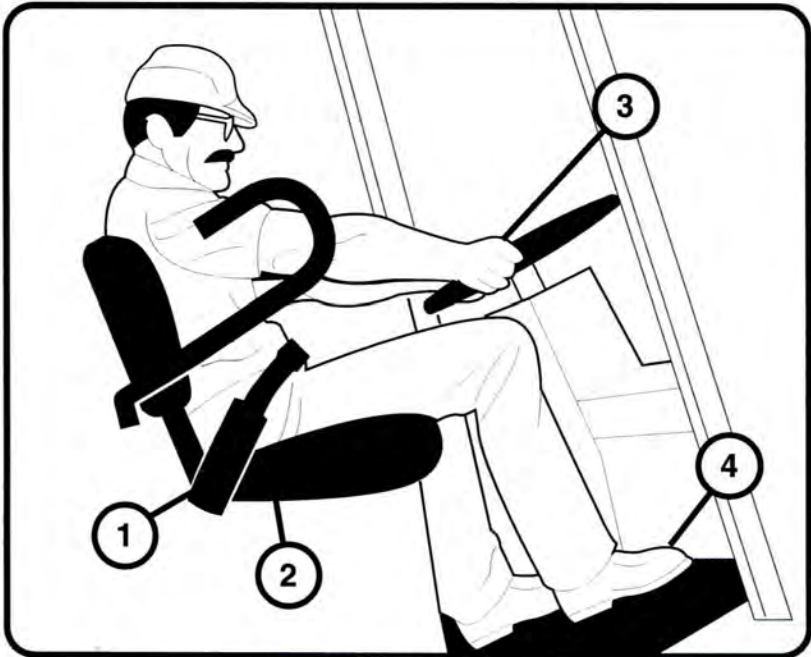

IMPORTANT

Your chances for survival in a tip-over are better if you stay with the truck, in your seat.

IMPORTANT

Seat belts can reduce injuries.

ALWAYS BUCKLE UP

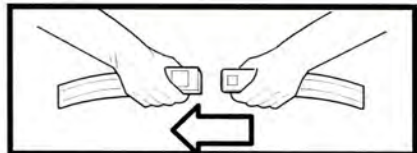

Surface and Capacity

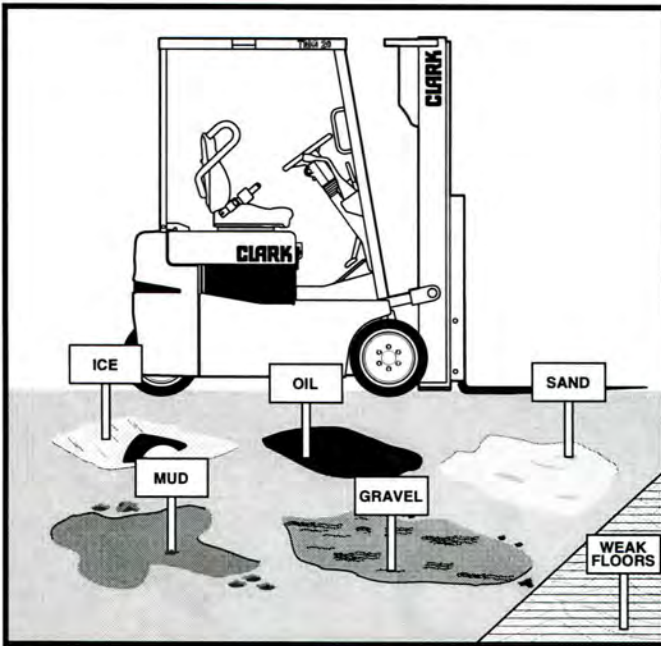

Avoid these conditions. They can cause a truck to tip over or lose traction for braking or driving.

WARNING

Know the weight of your truck and load. Especially when using elevators. Know the capacity of the elevator you intend to use. Do not overload.

Parking

Never park on a grade.



Always come to a complete stop before leaving truck. Be sure travel control is in NEUTRAL.

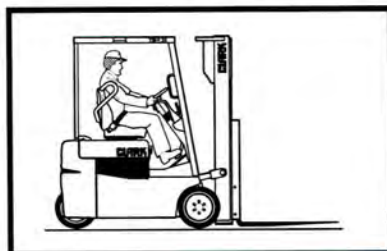

Lower forks fully to floor and tilt forward.

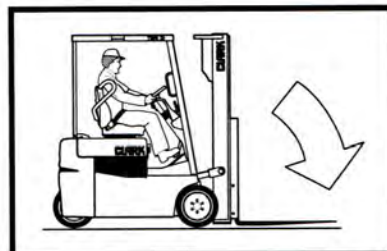

Set parking brake.

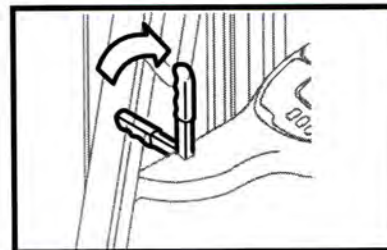

Turn key to OFF position.



Operating Hazards

Contents

Loose Loads	2-2
Long and Wide Loads	2-3
Rear Swing	2-3
Low Overhead Clearance	2-4
Drop-Offs	2-5
Right-Angle Stacking	2-6
Chain Slack	2-7
Pallets and Skids	2-8



This Section shows some of the hazards that may cause you, or someone around you, to be killed or badly hurt. As the operator, you must look for other hazards. Get your supervisor to help you identify and avoid those hazards.

Loose Loads



WARNING

Loose or unbalanced loads are dangerous. Observe these precautions.

Never carry loose or uneven material.

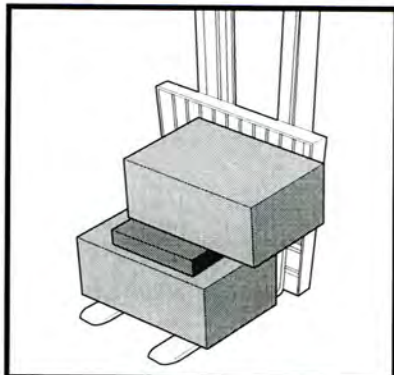

Center wide loads.

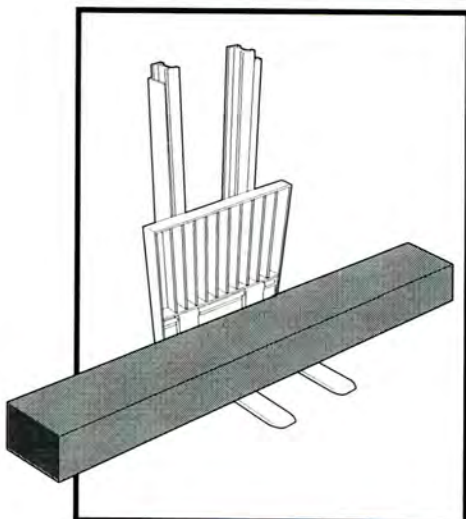

Stack and band loose material.

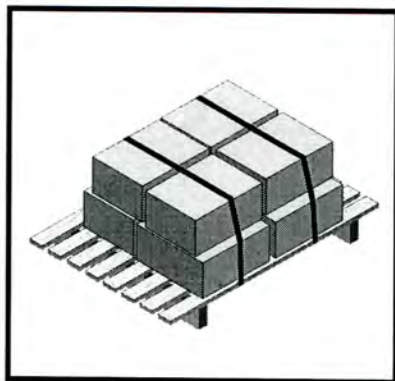

Long and Wide Loads

WARNING

With long or wide loads, you need more room. So slow down and watch your clearance.

When extra-long material makes it necessary to travel with the load elevated, do so with extreme care and be alert to load end-swing when turning.

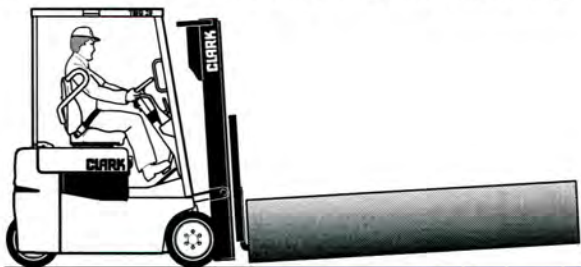

WARNING

A long load reduces the capacity of the truck. Know and understand your truck load rating.

Rear Swing



WARNING

When turning, be sure the rear end of the truck does not swing into racks, posts, etc. Watch for pedestrians beside the truck.

Low Overhead Clearance

WARNING

Know the height of your truck, with and without a load. Check your clearances. Keep the load low and tilted back.

WARNING

Watch overhead clearance: Moving into overhead structures can tip a truck over, or spill a load.

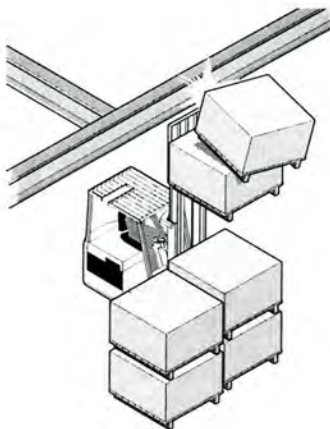

Fast Turns and High Loads

WARNING

Slow down before turning. The truck can tip over. Turn too sharp with a raised load and your truck can tip even at slow speeds. Travel with a load raised only when removing or depositing a load.



Drop-Offs

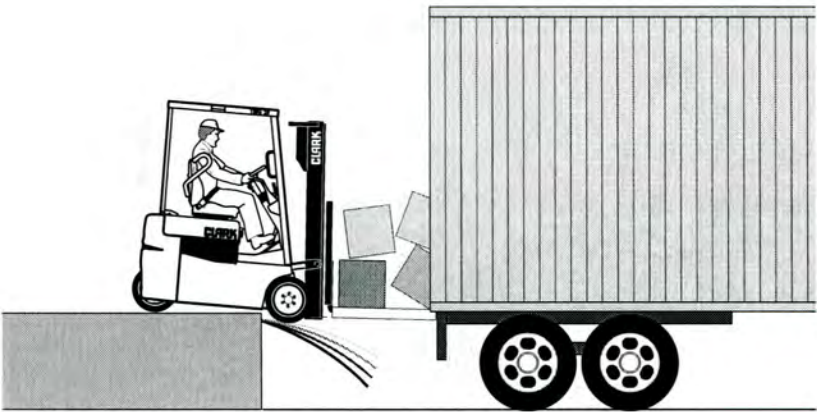

WARNING

To avoid these hazards, you must:

- Talk to the truck driver yourself; make sure the driver does not move the trailer until you are done!
- Apply trailer brakes.
- Use wheel chocks.
- Use trailer-to-dock locking system if available.

The impact of moving in and out of a trailer may cause the trailer to creep or move.

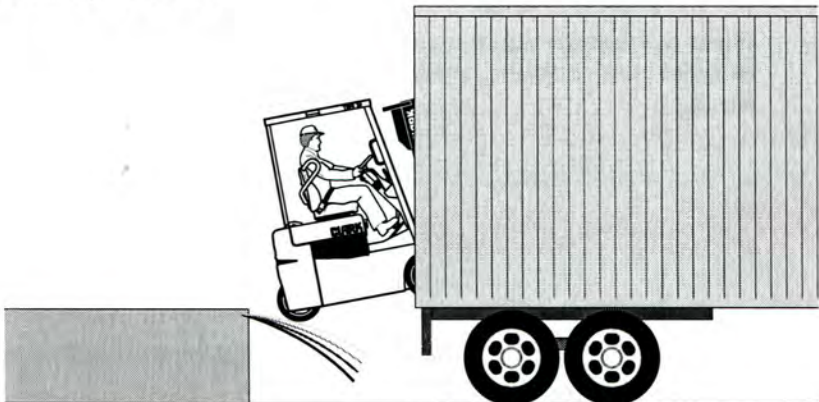

Right-Angle Stacking

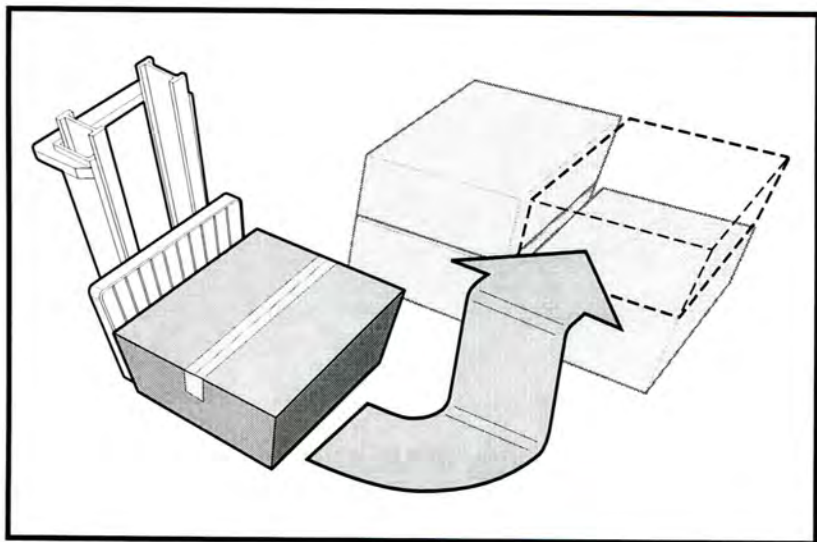

SLOWLY



WARNING

When right-angle stacking or moving with a raised load to clear low objects, avoid sharp turns and move slowly.

Chain Slack

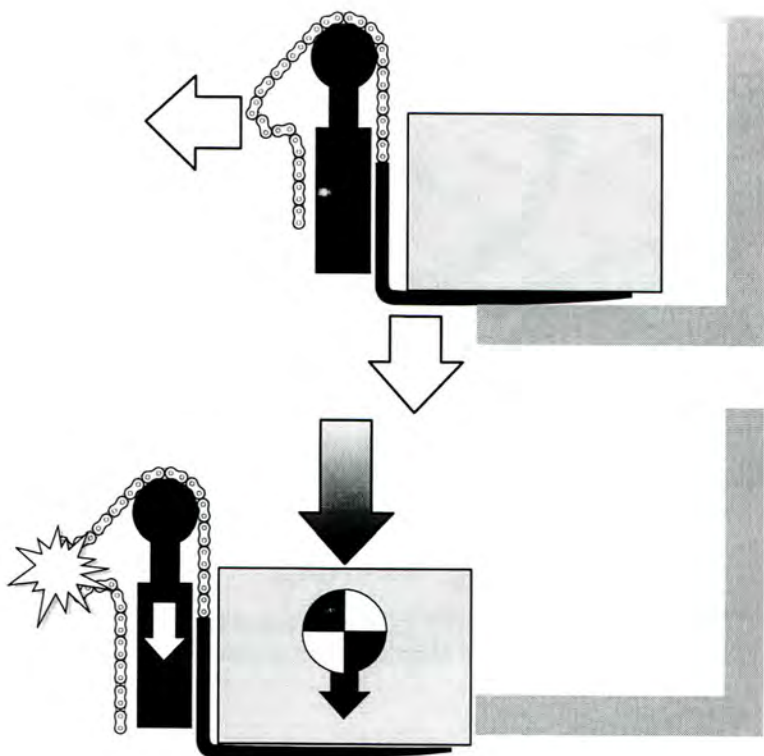

WARNING

Slack chains mean rail or carriage hang-up. Raise the forks before you move, or broken chains can result.

Pallets and Skids

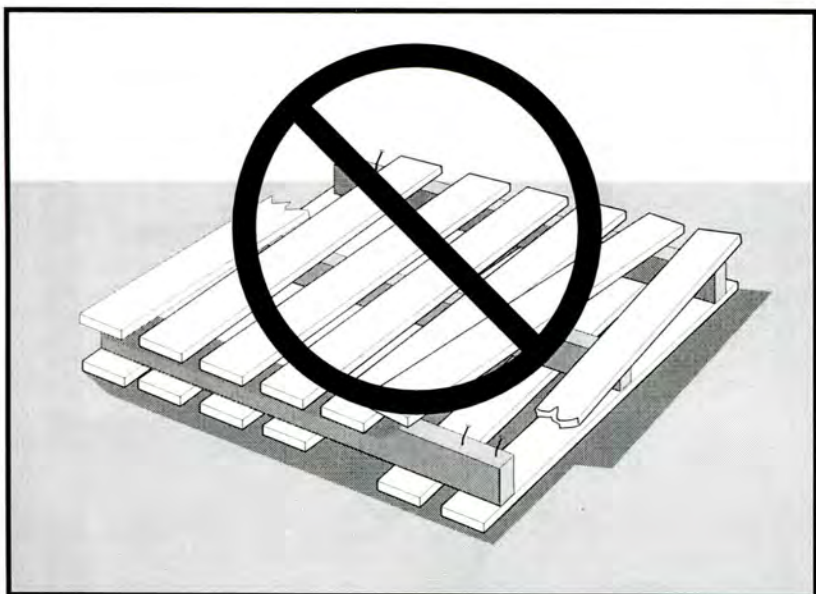

WARNING

Do not move or store materials on damaged pallets or skids. Items can fall through them causing severe injury or death!

Be sure the pallet or skid you are using is in good condition and does not have defective or missing components and fasteners.

Know Your Truck

Contents

Truck Model Description	3-2
Nameplate and Safety Decals	3-3
Operator Compartment Layout	3-7
Dash Display	3-8
Direction Control Lever	3-8
Command System Display (Opt)	3-9
Accelerator Control Pedal	3-12
Service Brakes	3-12
Parking Brake	3-12
Steering Column Pylon	3-13
Handwheel and Horn Button	3-13
Seat Adjustment	3-13
Lift Control Lever	3-14
Tilt Control Lever	3-14
Auxiliary Control Lever (Optional)	3-14
Battery Compartment Access	3-15
Main Hydraulic System	3-16
Power Steering System	3-16

Truck Model Description

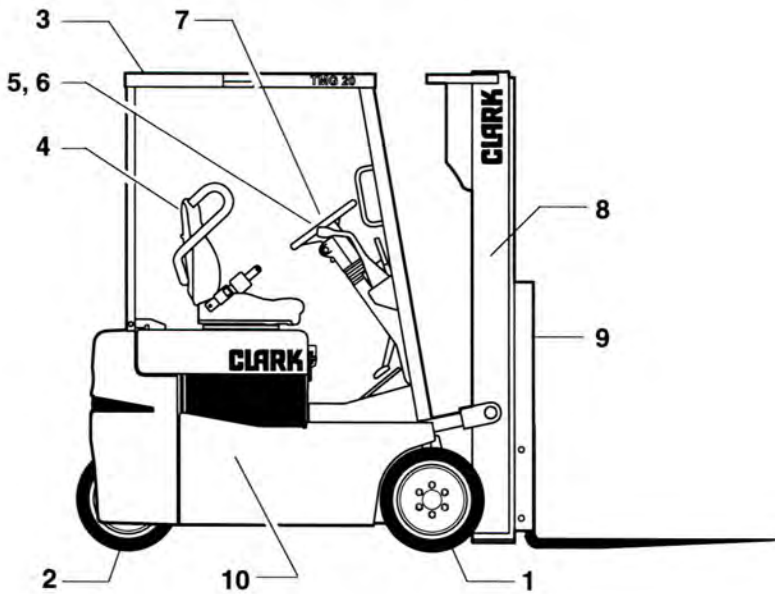

CLARK TMG 12-25

TRUCK TYPE: Electric Sit-Down Rider, 36/48 Volt, Cushion Tire, 2500 through 5000 lbs capacity.

1. Drive Axle, Cushion Tires, and Wheels
2. Steer Axle, Cushion Tires, and Wheels
3. Overhead Guard
4. Seat and Seat Belt
5. Hydraulic Function Levers
6. Steering Handwheel
7. Directional Control Lever
8. Upright
9. Load Backrest Extension
10. Battery Compartment

Nameplate and Safety Decals

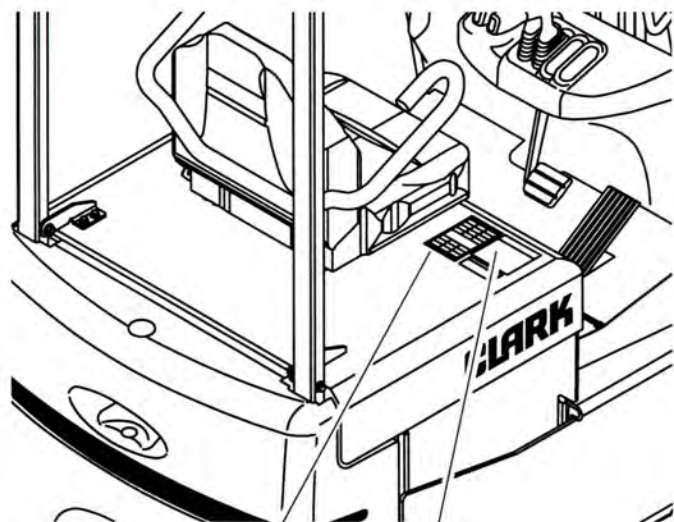

Truck Data and Capacity Plate (Truck Nameplate)

Operator Safety Warning Decal

Other safety and warning decals are placed in various conspicuous locations on the truck. Decals are provided to remind you of essential procedures or to prevent you from making an error which could damage the truck or possibly cause personal injury. It is important that you know, understand, and follow these instructions. Safety and warning decals should be replaced immediately if missing or defaced (damaged or illegible). Refer to the Service Manual for location of all decals.

NOTICE

NAMEPLATES AND DECALS: Do not operate a lift truck with damaged or lost decals and nameplates. Replace them immediately. They contain important information.

Truck Data and Capacity Plate

1. Truck model number or registered name.
2. Truck serial number—An identification number assigned to this particular truck and should be used when requesting information or ordering service parts for this truck from your authorized CLARK dealer. The serial number is also stamped on the frame.
3. Attachment description (if any installed)—The user must see that the truck is marked to identify the attachment(s), including the weight of the truck/attachment combination and truck capacity with the attachment.

CLARK From the factory this truck meets Part II ANSI B56.1

Model	1	Type
Serial No.	2	
Attachments	3	

A			in
B			mm
			lb
		4	kg
			lb
			kg
			lb
			kg
			in
			mm

Capacities are for centered loads only.
Capacities are with attachment or forks with upright in vertical position.

Truck Weight	lb or	kg
w / Max Battery	5	lb or kg
Max Battery	lb or	kg
Min Battery	lb or	kg
Max Amp Hrs.	Volts	No.

2811000
For other capacities consult Clark Material Handling Co., Lexington, KY

4. Capacity rating, load center, and lifting height data—Shows the maximum load capacity of this truck with relation to load centers and fork heights (see diagram on plate). Personal injury and damage to the truck can occur if these capacities are exceeded. **Do not exceed the maximum capacity specified.**
5. Truck weight—The approximate weight of the truck without a load on the forks. This weight plus the weight of the load must be considered when operating on elevators, elevated floors, etc. to be sure they are safe.

CAUTION

When attachments are added or if the truck is modified, the capacity of the truck may be affected. Contact your authorized CLARK dealer for a new nameplate showing the revised capacity.

IMPORTANT

It is OSHA law that written approval from the truck manufacturer is required before modifications to the truck that effect capacity or safety systems may be made.

Operator Safety Warning Decal

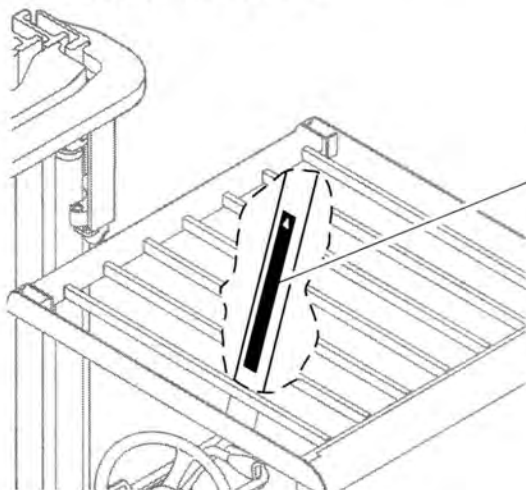

IMPORTANT

Safety and warning decals are placed in conspicuous locations on the truck to remind you of essential procedures or to prevent you from making an error that could damage the truck or possibly cause personal injury. You should know, understand, and follow these instructions. Safety and warning decals should be replaced immediately if missing or defaced (damage or illegible). Refer to your Service Manual for location of all decals.

Operator/Tip-Over Warning Decal

This decal is located on the front right hand leg of the drivers overhead. It is to remind the operator that staying in the seat provides the best chance of avoiding injury in the event of a truck-tipping or driving off a dock a dock mishap.

Lift trucks can be tipped over if operated improperly. Analysis of lift truck accidents has shown that the driver cannot react quickly enough to jump clear of the truck and overhead guard as the truck tips. To protect operators from severe injury or death in the event of a tip-over, it is best to be held securely in the seat. So, please, always buckle up when driving your lift truck. (see page 1.13)



Upright Warning Decal

This safety decal is on the upright to warn of the danger of injury from movement between rails, chains, sheaves, fork carriage, and other parts of the upright assembly. Do not climb on or reach into the upright. Personal injury will result if any part of your body is put between moving parts of the upright.



Keep Away from Forks Decal

This safety decal is placed on the upright to warn of the danger of injury from forks when they are in the raised position. Do not ride on or stand under forks or attachments. The forks can fall and cause injury or death. Always make sure that the forks are in the fully lowered position when they are not being used to handle a load.

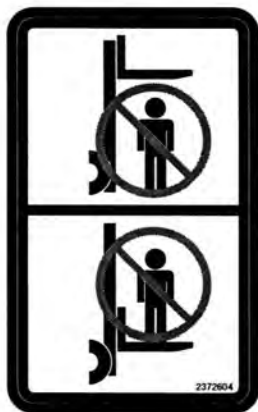

Battery Connector Warning Decal

This decal is placed next to the battery connector to warn of the danger of the truck starting in motion.



Operator Compartment Layout

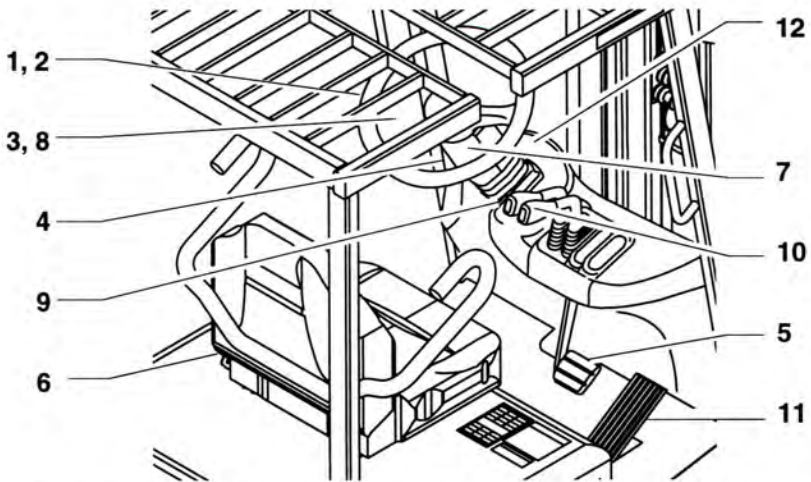

- | | |
|------------------------------|-------------------------------------|
| 1. Steering Handwheel | 8. Parking Brake Lever |
| 2. Horn Button | 9. Lift Control Lever |
| 3. Directional Control Lever | 10. Tilt Control Lever |
| 4. Pylon Release Lever | 11. Accelerator |
| 5. Brake Pedal | 12. Standard Display/Command System |
| 6. Seat | |
| 7. Key Switch | |

IMPORTANT

Familiarize yourself with the controls and follow safe operating rules.

Key Switch

The Key Switch:

- Connects the battery with all truck operating systems (drive, lift, and steer electrical circuits) except the horn.
- Connects battery to the diagnostic display hourmeter and battery charge status.

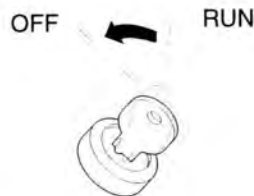

The key switch must always be turned to the ON position to operate the truck. When the key is in the vertical OFF position, instruments, drive, and pump motor electrical circuits are disconnected (shut off), and the key can be removed. The horn should operate at all times, if an adequately charged battery is connected at the truck receptacle.

Direction Control Lever

Direction of travel is selected with a control on the left-hand side of the steering column. The control lever has three positions:

The control lever is held positively in each position by spring detents in the lever assembly. Selection of travel direction may be noted by visual check of the lever position.

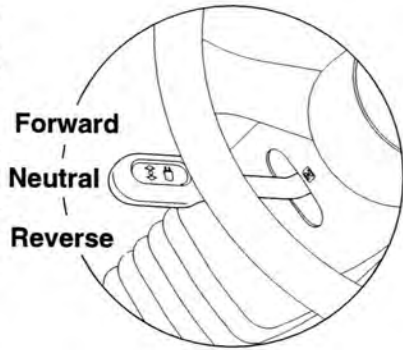

Dash Display

The primary design of the Dash Display is to provide the operator with an easily understandable, visual feedback of the status of the truck and its system components.

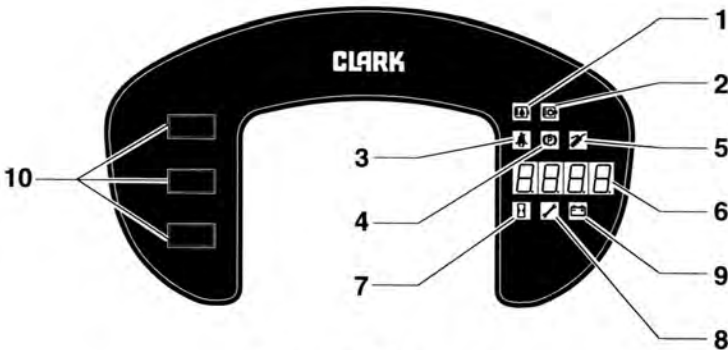

Standard Display

- | | |
|--|---------------------------------------|
| 1. Pump Motor Brush Wear Indicator (optional) | 5. Planned Maintenance |
| 2. Drive Motor Brush Wear Indicator (optional) | 6. Numeric Display |
| 3. Seat Belt Alert | 7. Hour Meter |
| 4. Park Brake | 8. Service Status |
| | 9. Battery Status |
| | 10. Accessory Switches (lights, etc.) |

Command System Display (Option)

The primary design of the Command System is to provide the operator with an easily understandable, visual feedback of the status of the truck and its system components. The operator can also select / change vehicle operating characteristics.

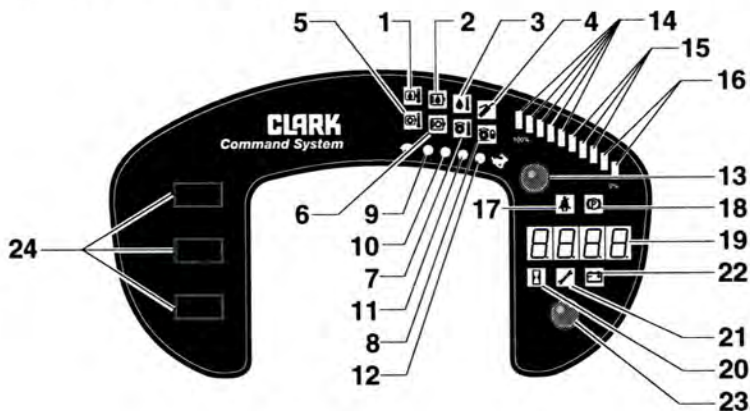
**Command System**

- | | |
|-----------------------------------|---------------------------------------|
| 1. Pump Motor Temperature (Opt) | 13. Performance Selector Button |
| 2. Pump Motor Brush Wear (Opt) | 14. Battery Level (high) |
| 3. Pump Control Temperature (Opt) | 15. Battery Level (med) |
| 4. Planned Maintenance | 16. Battery Level (low) |
| 5. Drive Motor Temperature (Opt) | 17. Seat Belt Alert |
| 6. Drive Motor Brush Wear (Opt) | 18. Park Brake |
| 7. Traction Control Temp (Opt) | 19. Numeric Display |
| 8. Drive Motor Overload | 20. Hour Meter |
| 9. Performance Mode 1 | 21. Service Status |
| 10. Performance Mode 2 | 22. Battery Status |
| 11. Performance Mode 3 | 23. Stored Status Code Button |
| 12. Performance Mode 4 | 24. Accessory Switches (Lights, etc.) |



Pump Motor Temperature: *(Optional)* The symbol is displayed to "alert" of pump motor temperature exceeding the design limits. **Do not use truck.** Allow pump motor to cool until after symbol turns "OFF".



Pump Motor Brush Wear: *(Optional)* The symbol is displayed to warn one or more of the pump motor brushes are worn beyond allowable length. **Do not use truck.** Call service to replace brushes.



Drive Motor Brush Wear: *(Optional)* The symbol is displayed to "alert" of drive motor temperature exceeding the design limits. **Do not use truck.** Allow drive motor to cool until after symbol turns "OFF".



Seat Belt: At start up this symbol displays along with an audio alarm for 4 seconds. This display reminds you to fasten your seat belt.



Parking Brake: The symbol is displayed and "-01" status code appears on the numeric display when parking brake is applied. Release parking brake to operate truck.



Planned Maintenance: This symbol is displayed and "-99" status code appears on the numeric display when the key switch is turned "ON" and trucks operating hours exceed pre-programmed hours for planned maintenance. The symbol is a reminder only and will turn "OFF" after 4 seconds and display will return to normal operation. The truck shall be inoperative while this symbol is displayed. **Call Service.**



Hour Meter: This symbol identifies the number displayed on numeric display as truck and/or pump motor (optional) operating hours. The symbol is displayed for 4 seconds to 8 seconds when the key switch is turned "OFF".



Service Status: "-01 through -03," "-06 and -08" are usually operator fault codes, and can be corrected by as explained in "Section 5, Operating Procedures." If you see any other codes displayed, the truck needs to be serviced.



Battery Status: If this symbol displays, the numeric display shows the percentage of usable charge remaining on the battery.



Pump Control Temperature: *(Optional)* The symbol is displayed and "-141" status code appears on numeric display to "alert" of main transistor on pump control exceeding allowable design limits. Do not use truck. Allow control to cool until symbol turns "OFF". **Call Service.**



Traction Control Temperature: *(Optional)* The symbol is displayed and "-41" status code appears on numeric display to "alert" of main transistor on traction control exceeding allowable design limits. Do not use truck. Allow control to cool until symbol turns "OFF". **Call Service.**



Drive Motor Overload: This symbol will come on when the drive motor is stalled or overloaded. The numeric display will show a status code "-82" - "-83" when this occurs.



Drive Motor Temperature: *(Optional)* The symbol is displayed to "alert" of drive motor temperature exceeding the design limits. **Do not use truck.** Allow motor to cool until after symbol turns "OFF".



Performance Selector Button: Used in conjunction with stored status code access button to select one of the four available pre-programmed sets of performance characteristics of the truck. (see page 5-4)



Stored Status Code Button: Used in conjunction with performance selector button to retrieve the failure history. (up to 16 status codes with associated state of battery and truck operating hours). (see page 5-4)



Battery Level: Graphical display showing state of charge.

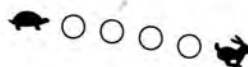

Performance Mode Levels: Selected level of operating characteristic of the truck from the 4 available sets of pre-programmed operating characteristic.

Accelerator Control Pedal

The accelerator pedal controls the required speed and power. The accelerator pedal connect to the accelerator control mounted directly beneath the floorboard.

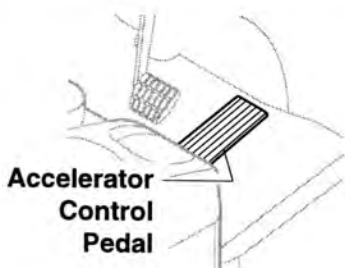

Service Brakes

Your truck has a manual service brake system with a single pedal that actuates the master cylinder. The brake master cylinder reservoir is located on the cowl behind the covers. The master cylinder reservoir requires DOT 3 brake fluid.



CAUTION

Never operate your lift truck with the service or parking brakes not working correctly.

Parking Brake

The parking brake lever, mounted at the left of the steering pylon, mechanically operates the parking brakes. The lever is connected by cable to the braking mechanism in the drive assembly.

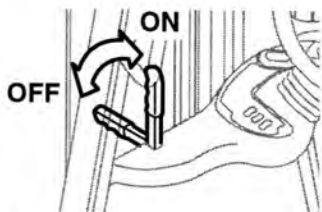

Pull the lever toward the operator to apply the parking brake. The lever should snap-lock easily into the applied position, when correctly adjusted. Push the lever forward (away from the operator) to release the parking brake.



CAUTION

Always apply parking brake before leaving truck.



WARNING

Never operate your lift truck with a defective parking brake.

Handwheel and Horn Button

The horn button is located in the center hub of the steering handwheel and is electrically connected by contacts and wiring to the horn assembly.

Steering Column Pylon

The steering column pylon can be tilted forward or backward to aid steering comfort and to allow battery removal.

To release the pylon, pull the latch handle upward as you tilt the pylon to the desired position.

To lock the pylon, release the lever.

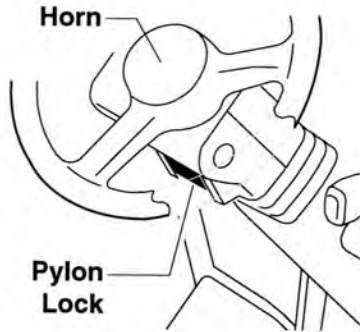

Seat Adjustment

Fore-and-Aft

The fore-and-aft adjustment lever is located on the right side under the seat. To unlock, push the lever to the left and adjust the seat, release the lever. Be sure that the seat locking mechanism is engaged.

Back Angle Adjustment (Option)

To adjust the angle of the seat back turn the knob on the right side of the drivers seat. To tilt the seat back, turn the knob counter-clockwise. To tilt the seat back forward, turn the knob clockwise.

Weight Adjustment (Option)

This adjustment allows you to set the cushion of the ride to the weight of the individual operator.

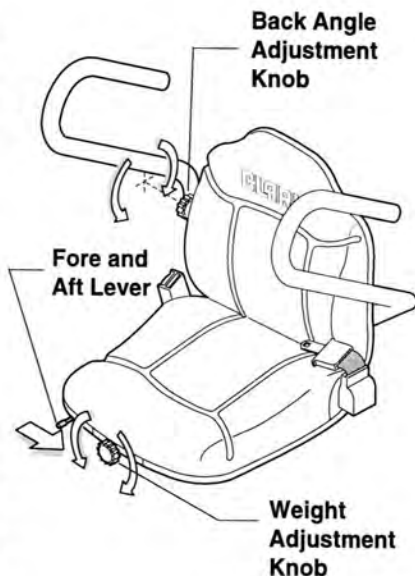

CAUTION

Never adjust driver's seat while truck is moving, to avoid the possibility of loss of control and of personal injury.

Hydraulic Control Levers

The hydraulic controls are mounted on the dash within easy reach of the operator. The hydraulic levers actuate the lift, tilt functions and any other hydraulic devices which are installed on the truck.



Lift Control Lever

The lift control lever raises and lowers the fork carriage on the upright. The lifting and lowering speeds are controlled through the main hydraulic valve by varying the lever position (amount of movement from center or neutral position).

When the lift control lever is pushed forward, the fork carriage is lowered. By varying the amount of movement of the lever from the center or neutral position, you determine the lowering speed. You can lower the fork carriage even if the key switch is OFF.

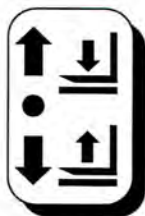

Tilt Control Lever

With the tilt control lever, you are able to control the tilting or vertical positioning of the upright and the angle of the forks. When the lever is pulled back, the upright and forks tilt backward. Push the lever forward to tilt the upright and forks forward.



Auxiliary Control Lever (Option)

An auxiliary control lever is mounted to the right of the tilt control lever. If your lift truck is equipped with an optional attachment, this lever will control the flow of hydraulic oil to the attachment.

Battery Compartment Access

The combination seat deck/battery compartment cover pivots upward to provide access to the battery compartment.

You must tilt the steering column pylon forward before raising the cover. The cover is held closed by a gas spring. Pull the latch to release the cover.

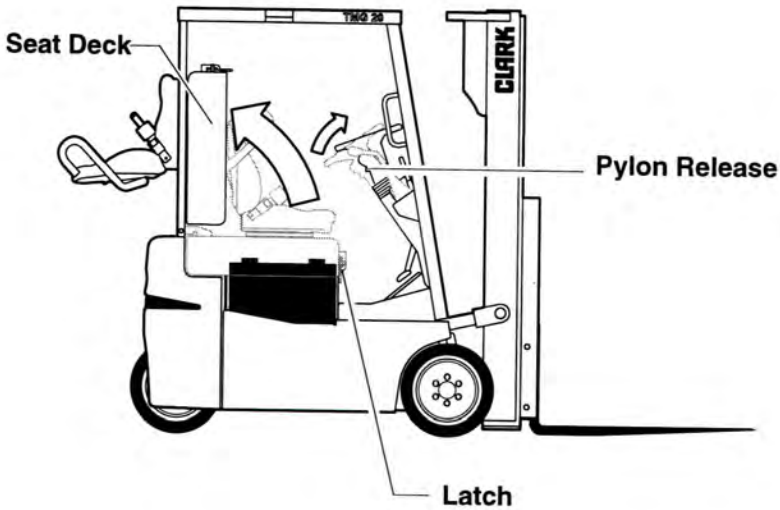

Main Hydraulic System

The main hydraulic system consists of a hydraulic sump tank, main hydraulic pump and motor, main control valve, and associated hydraulic lines and hoses.

The hydraulic sump is a separate, removable tank in the left-hand side compartment of the truck frame.

Oil from the hydraulic sump is fed by a gear pump to the main control valve. From the main control valve, the oil is directed to the lift cylinders, tilt cylinders, or back to the sump. Filtration of the main hydraulic system oil is provided through a spin-on, full-flow return line filter in the steering circuit.

Power Steering System

All TMG12-25 trucks are equipped with a hydrostatic power steering system. Full-time power steering is provided by oil pressure from a separate electric motor and pump. Oil for the power steering system is drawn from the main hydraulic sump and circulated back to the sump through the return-line filter.

The steering handwheel operates a steering control valve that directs oil flow to the single acting steering cylinder on the steering assembly. The steering control valve can also act as a pump to provide manual steering if the steer motor (steer pump flow) stops.



CAUTION

Never operate a lift truck that has a steering system fault.

Daily Safety Inspection

Contents

Inspecting Your Truck	4-2
Visual Checks	4-3
Functional Checks	4-4
Concluding the Inspection	4-5

NOTICE

The Occupational Safety and Health Act (OSHA) requires that truck users inspect their trucks before each shift to be sure they are in safe working order. Defects, when found, shall be immediately reported and corrected. The truck shall be taken out of service until it has been restored to safe operating condition.

Inspecting Your Truck

Before using a lift truck, **it is the operator's responsibility** to check its condition and be sure it is safe to operate.

Check for damage and maintenance problems. Have repairs made before you operate the truck. Unusual noises or problems should be reported immediately to your supervisor or other designated authority.

Do not make repairs yourself unless you have been trained in lift truck repair procedures and authorized by your employer. Have a qualified mechanic correct all discrepancies using genuine CLARK or CLARK-approved parts.

Do not operate a truck if it is in need of repair. If it is in an unsafe condition, remove the key and report the condition to the proper authority. If the truck becomes unsafe in any way while you are operating it, **stop** operating the truck, report the problem immediately, and have it corrected.

Lift trucks should be inspected every eight hours, or at the start of each shift. In general, the daily inspection should include the **visual** and **functional checks** described on the following pages.

As an aid in carrying out this inspection, CLARK has prepared a form called the "**Driver's Daily Checklist.**" We recommend that you use this form to make a daily record of your inspections and truck condition. You may obtain copies of this form from your CLARK dealer.



WARNING

Leaking hydraulic oil may be hot or under pressure. When inspecting a lift truck:

- **Wear safety glasses**
- **Do not check for leaks with bare hands.**

Visual Checks

First, perform a visual inspection of the truck and its major components:

1. Walk around your lift truck and take note of obvious damage that may have been caused by operation during the last shift.
2. Check that all capacity, safety, and warning plates or decals are attached and legible.
3. Check that the battery is installed and secured in position correctly. Check battery connector for safe condition.
4. Look for any external leakage around drive axle.
5. Check for hydraulic oil leaks and loose fittings. Do not use bare hands.
6. Be sure that the driver's overhead guard and any other safety devices are in place, undamaged, and attached securely.
7. Check all of the critical components that handle or carry the load.
8. Check the upright and lift chains. Check for obvious wear and maintenance problems such as damaged or missing parts, leaks, slack or broken chains, bent parts, and so on.
9. Carefully inspect the load forks for cracks, breaks, bending, twists, and wear. Be sure that the forks are correctly installed and locked in their proper position.
10. Inspect the wheels and tires for safe mounting and wear condition.
11. Check the hydraulic sump oil level.

Functional Checks

Check the operation of the truck as follows:

NOTICE

Before performing these checks, familiarize yourself with the operating procedures in Section 5, "Operating Procedures." Be sure there is enough overhead clearance to fully raise the upright.

1. With key switch off be sure all controls and systems operate freely and return to neutral properly. Check the:
 - Service and parking brakes
 - Hydraulic controls: lift, tilt, and aux functions (if installed)
 - Accelerator control
 - Directional control
 - Steering system
2. Test warning devices, horn, lights, and other safety equipment and accessories.
3. With the truck on, check the Command System display. The diagnostic display should show the charge remaining on the battery or a fault code. If the fault code is not an operator fault code (described in Section 5, "Operating Procedures" under "Using the Diagnostic Display"), call a service technician.
4. Check hydraulic fluid level: With the truck parked on a level surface, lift the carriage to maximum height while listening for a high-pitched squeal. This sound, called "cavitation," indicates the fluid is low. Add just enough to stop the cavitation".

When the functional checks are completed:

1. Bring truck to a complete stop.
2. Put the directional control lever in the NEUTRAL position.
3. Apply the parking brake.
4. Turn the key switch to the OFF position.
5. Lower the lift mechanism fully.

If you are going to leave the truck unattended:

6. Remove the key.
7. Block the wheels if the truck has any possibility of moving.

Concluding the Inspection

Make a record on the "Driver's Daily Checklist" of all the operating and truck problems that you find. Review the checklist to be sure it has been completed and turn it in to the person responsible for lift truck maintenance. Be sure any unusual noises or problems are investigated immediately.

Do not operate a lift truck that has a maintenance problem, or is not safe to operate.

Remove the key from the ignition switch and put an "Out of Service" tag on the truck.



If all of the Daily Inspection checks were normal or satisfactory, the truck can be operated.

Operating Procedures

Contents

Before Operating the Truck	5-2
Starting from a Safe Condition	5-3
Adjusting the Seat	5-4
Buckling Up	5-4
Starting the Truck	5-4
Using the Diagnostic Display	5-5
Positioning Forks and Upright	5-6
Controlling Speed	5-7
Braking	5-7
Plugging	5-7
Operating Safely	5-8
Adjusting the Load Forks	5-11
Load Handling	5-12
Traveling with a Load	5-13
Picking Up and Moving Loads	5-14
Unloading	5-14
Stacking	5-15
After Operating the Truck	5-17

Before Operating the Truck

Be sure that you have read and understand the information in this *Operator's Manual* before operating the lift truck.

The Operator's Manual Holder is located on the back of the seat.

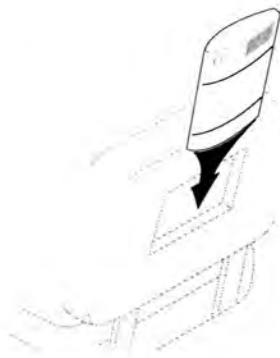

WARNING

- This equipment can be dangerous if not used properly. Safe operation is the responsibility of the operator.
- Do not start or operate the truck, or any of its functions or attachments, from any place other than the designated operator's position.

CAUTION

- Inspect your lift truck before operating at the start of the day or shift. Before putting your truck to use, check the operation of the controls and all systems.
- Protect yourself. Do not operate truck without a driver's overhead guard unless conditions prevent its use. Do not remove overhead guard unless specifically authorized. Use special care if operation without this safety device is required.

Starting from a Safe Condition

Always start from a safe condition. Before operating a lift truck, make sure that:

1. Parking brake is applied.
2. Forks are fully lowered to the floor or ground.
3. You are familiar with how all the controls function.
4. All controls are in neutral or other correct position.
5. Truck has received its daily inspection and is ready and safe to operate.

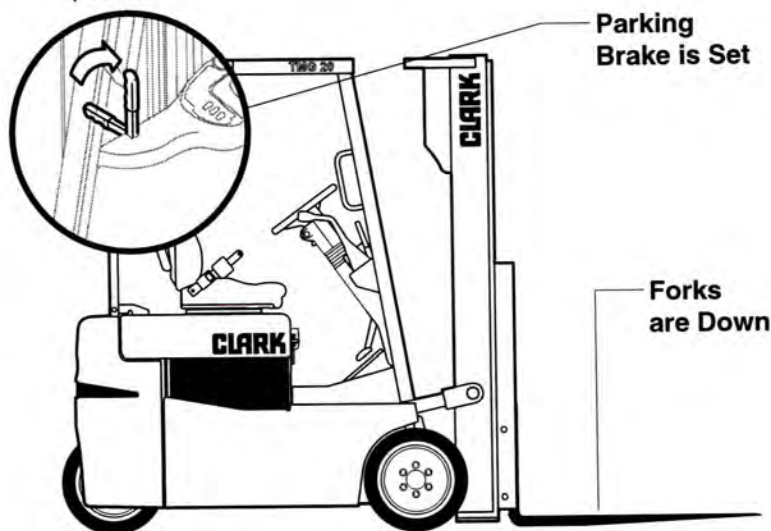

Put the direction control lever in the **NEUTRAL** position, before turning the key switch to ON.

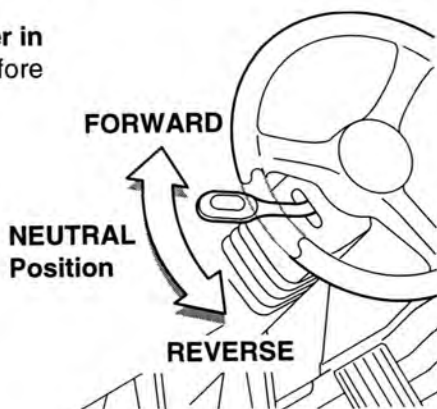

Adjusting the Seat

Adjust the seat to a comfortable position for you. Adjust the seat by moving and holding the release lever at the front edge of the seat. Put the seat in a position that will provide easy reach to all controls. Release the seat lever. Make sure that the seat locking mechanism is engaged.



CAUTION

Never adjust the driver's seat while the truck is moving, to avoid the possibility of loss of control and of personal injury.

Buckling Up

Buckle up. Be sure that you put on the seat belt. Connect and adjust the seat belt strap to a snug, comfortable position.

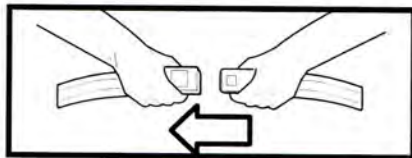

WARNING

Always wear your seat belt when operating a lift truck.

Starting the Truck

Before you start the truck, make sure that you have taken all the above-mentioned precautions and that the directional control is in NEUTRAL. To start the truck, turn the key switch clockwise to the ON position.

Selecting Performance Level on Command System (Optional)

Depress and hold green and white push button switches for two (2) seconds with key on and truck in neutral. Release switches when "wrench" symbol starts flashing. Cycle (push/release) white switch to choose desired performance level between turtle and rabbit icons as shown by lit LED. Depress and hold green switch for (2) seconds till selected level LED start flashing. Release green switch and "wrench" symbol will turn off.

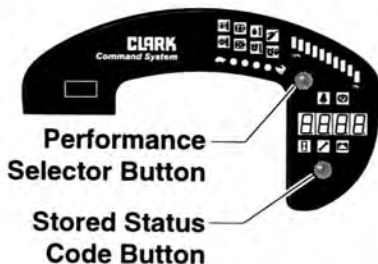

Using the Display

The display should turn "ON" all symbols and "8888" appear on numeric display for about 2 seconds when the key switch is turned "ON". After 2 seconds, all displays should return to normal operating conditions except seat belt reminder symbol which will continue to be displayed for 2 additional (4 seconds total) while the seat belt buzzer (alarm) sounds.

If the battery symbol light comes on, the digital readout shows the percentage of charge remaining on the battery. When the remaining charge registers as 20% or less, the readout flashes. At 10% remaining charge, the lift and tilt functions become inoperable.

If the wrench symbol comes on, a status code appears on the digital readout. The status code may indicate an easily correctable "operator fault" or it may indicate that you need to have the truck serviced.

If you see a status code, use the table below as a guide. Codes -01 through -06 or 11 are usually the operator errors. Any other code is a service code.

Code	Condition	Likely Corrective Action
-01	Parking brake or seat switch open	Release parking brake.
-02	Direction control in FORWARD when key turned ON	Put direction control in NEUTRAL before starting.
-03	Direction control in REVERSE when key turned ON	Put direction control in NEUTRAL before starting.
-05	Brake and accelerator depressed at same time	Use only one at a time.
-06	Accelerator depressed with NEUTRAL selected	Select direction first.
-11	Accelerator depressed when key is turned on.	Remove foot from accelerator before starting.
Other	Truck needs service	Call service technician.

A complete listing of status codes appears in the service manual. When you return the key switch to the OFF position, the hourglass symbol light should come on, and the hours registered on the truck should appear on the digital readout for about four seconds.

Positioning Forks and Upright

When driving, with or without a load, it is good practice to have the forks slightly raised and tilt the upright (forks) backward. Having the forks raised and tilting back prevents the fork tips from catching on possible obstructions and reduces the wear on the fork blades from striking or dragging on the floor or ground. See the NOTICE and CAUTION below.

Pull back on the lift control lever and raise the forks 6 to 8 inches (152 to 203 mm) above the floor. Then, using the tilt control, tilt the upright back slightly to raise the fork tips.

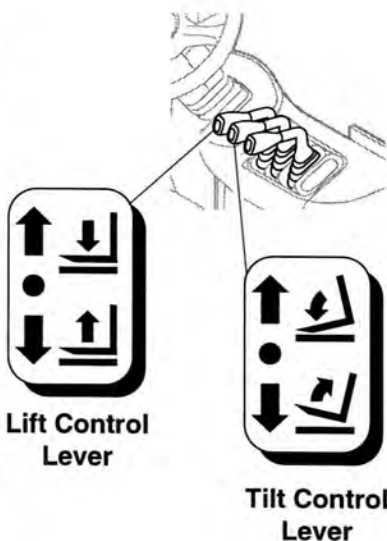

NOTICE

When the upright (carriage and/or load) is raised into a high (elevated) position, the stability of the truck is reduced. Some of the other conditions that may affect stability are: ground and floor conditions, grade, speed, loading, dynamic and static forces and the judgement exercised by the operator. Trucks equipped with attachments behave as partially loaded trucks even when operated without a load on the attachment. Also, improper operation, faulty maintenance or poor housekeeping may contribute to a condition of instability.

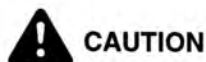

CAUTION

For stability reasons, do not travel with the load or carriage in a highly elevated position. Travel with the lift mechanism raised only enough to clear the ground or obstacles.

Controlling Speed

With the direction control in FORWARD or REVERSE, the parking brake released, put your foot on the accelerator pedal and push down smoothly until the truck is moving at the desired speed.

Braking

To stop the truck, lift your foot from the accelerator pedal and put it on the brake pedal. Push down on the brake pedal in a smooth, firm motion until the truck is stopped.



IMPORTANT

Stop a lift truck as gradually as practical. Hard braking and wheel sliding are dangerous and can cause tip-over or the truck could lose its load. Also hard braking can increase wear and can be harmful to the lift truck.

Plugging

You can change direction, without braking, by "plugging." As you are traveling, move the direction control lever to the opposite direction and keep the accelerator pedal depressed. The truck should slow to a smooth, controlled stop and then accelerate in the opposite direction. You can control the plugging distance with the accelerator pedal: The farther the accelerator is depressed, the shorter the reversal distance. By lifting your foot from the accelerator pedal as the truck comes to a stop (before going in the opposite direction) the truck can be stopped without use of the brakes.



CAUTION

Be careful when plugging. Any sudden change in direction can cause the load to move or fall off the forks.

Operating Safely

IMPORTANT

Safe operation is the responsibility of the operator. Watch where you are going. Don't go if you can't see.

Before driving, check all around to be sure that your intended path of travel is clear of obstructions and pedestrians.

While driving, be alert for pedestrians, other vehicles or obstructions in your path of travel.

Watch people. Do not allow anyone to stand or pass under the load or raised forks. Watch for people in your work area even if your truck has warning lights or alarms. They may not watch for you.



Sound horn at intersections and wherever vision is obstructed. Do not drive a truck up to anyone standing in front of an object.

Protect yourself and those around you...

Operate the truck only from the designated operator's position. Stay within the confines of the lift truck profile dimensions. Keep arms, legs and hands inside the operator's compartment and away from the danger of passing obstructions. Keep under the overhead guard.

NOTICE

An overhead guard is intended to offer protection to the operator from falling objects, but cannot protect against every possible impact. Therefore, it should not be considered a substitute for good judgement and care in loading, handling, storage, etc..

Keep clear of the upright and lift mechanism. NEVER reach into or put hands, arms, legs or head into or through the upright structure or near the carriage or lift chains. Never put any part of your body between the upright and the truck. Don't use the upright as a ladder.

Keep all other persons clear of the load and upright mechanism while attempting to handle a load.

No riders...

Do not carry passengers. The operator is the only one who should be on the truck.

Always be in full control of your lift truck...

Never operate a lift truck or its attachments if you are not in the designated operator's position.

Never operate a lift truck when your hands are wet or greasy.

Always pick the smoothest travel route for your lift truck. Avoid bumps, holes, slick spots, and loose objects or debris in your path that may cause the truck to swerve or tip. If these conditions are unavoidable, slow down and carefully drive past them. Slow down for wet or slippery surfaces.

When handling bulky loads that restrict your vision operate your truck in reverse to improve visibility. Be sure to pivot in the seat to give maximum visibility.

Avoid any sudden movement. Start, stop, travel, steer, and brake smoothly.

Operate your lift truck under all conditions at a speed that will permit it to be brought safely to a stop.



WARNING

Travel slowly when turning. Use special care when traveling without a load because the risk of tipping over is greater with an empty truck, especially at high speed and when cornering.

Travel with the fork carriage tilted back and raised only enough to fully clear the ground or obstacles. When the carriage (load) is in an elevated position the stability of the truck is reduced.

Do not elevate the load except during stacking.

Grades, ramps, and inclines...

Use special care when operating on ramps, inclines, and uneven areas. Travel slowly. Travel straight up and down. Do not turn or drive at an angle across an incline or ramp.

When the truck is loaded, travel with the load upgrade. When the truck is empty, travel with lifting mechanism (upright) downgrade.

Practice safe operation every time you use your truck...

Careful driving and operation is your responsibility. Be completely familiar with all the safe driving and load handling techniques in this operator's manual. Use common sense. Drive carefully; do not indulge in stunt driving or horseplay. Observe traffic rules. Watch for people and hazards. Slow down. Be in full control of your lift truck at all times.

Follow the instructions in this manual to avoid damage to your truck or the possibility of injury to yourself or others.

During your work, observe all functions of your lift truck. This allows you to immediately recognize a problem or irregularity that could affect the safe operation of your truck.

Periodically check the gauges and warning indicator lights in the instrument panel to be sure they indicate a normal condition. If an abnormal condition appears, shut off the key switch immediately and report the problem.

IMPORTANT

**Do not continue to operate a truck that has a malfunction.
Stop and have it fixed.**

IMPORTANT

**Always wear your seat belt
when operating your lift truck.**

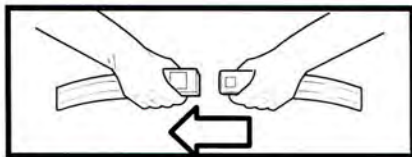

**CAUTION**

Operate your lift truck only in areas that have been approved for your lift truck type designation. Certain areas contain flammable gases, liquids, dust, fibers, or other hazardous materials. Lift truck operations in these areas must have special approval. These areas must be designated to show the type of lift truck approval required for operation in the area. Be aware that changes to special equipment or poor maintenance can cause the lift truck to lose its special approval.

Be sure that your truck is the correct fire safety type for the area in which you are working. The proper type designation for this truck is listed on the nameplate. In areas classified as hazardous, use only trucks approved for use in those areas. If you are unsure of the classification of the area you wish to enter, check before entering.

Adjusting the Load Forks

The load forks are adjustable on the hanger shaft. Forks should be spaced as far apart as the load being carried will allow. Both forks should always be the same distance from the center of the fork carriage. To adjust the forks, raise the carriage slightly. Tilt the upright fully forward to reduce friction and make the forks slide easier. Unlock the fork locking pins. Position the forks. Secure the fork locking pins.

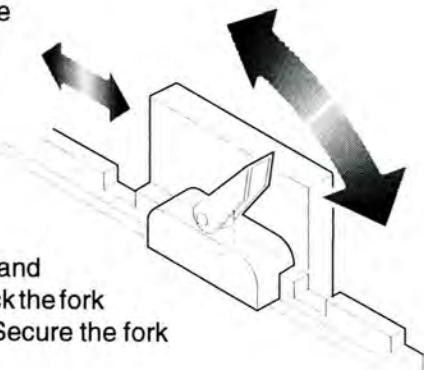
**CAUTION**

Forks are heavy, keep fingers clear. Move forks by pushing with one foot while holding on to the load back rest with hands. Be sure to have firm footing before attempting to move forks. Do not attempt this where the floor is slippery or wet.

Load Handling

Handle only loads that are within the truck rated capacity as shown on the nameplate. This rating specifies the maximum load that should be lifted. However, other factors such as special load handling attachments, loads having a high center of gravity, or uneven terrain may dictate that the safe working load be less than the rated capacity. Under these conditions, the operator must reduce the load carried so that the lift truck remains stable.

Handle only stable or safely arranged loads. Do not handle loads made up of loose, unevenly stacked or unstable items that can easily shift and fall. Take the time to correctly stack and band loose items. Center the load on the forks.

Do not lift anything that might fall on the operator or a bystander.

Do not handle loads that are higher than the fork carriage unless the load is secured so that no part of it can fall backwards.

Keep the load back against the carriage. Loads placed out on the ends of the forks can make the lift truck less stable and more likely to tip up.

Lift and lower with the upright mast vertical or tilted slightly back — **never tilted forward.**

Operate lift and tilt controls slowly and smoothly. Never tilt forward when carriage (load) is raised, except to pick up or deposit a load over a rack or stack.



WARNING

Slack chains mean rail or carriage hang-up. Raise the upright before you move. If the upright malfunctions in any way or becomes stuck in a raised position, operate the lift control to eliminate any slack chains. DO NOT go under a raised upright or forks to attempt repairs. DO NOT climb on upright to free hang-up.

Remember, your lift truck is designed to carry loads forward of the front wheels so that the weight of the load is counter-balanced by the weight of the truck.

The farther the load is carried from the pivot point (center of front wheels), the greater will be the uplift at the rear of the truck. Therefore, always carry the load as close to the front wheels as possible (back and flush against the face of the forks).

The capacity load shown on the nameplate is represented by a cube in which the weight is evenly distributed, with the center of gravity located a standard distance from the face of the forks. If the weight of the actual load to be handled is not evenly distributed, put the heaviest part closest to the carriage.

Traveling with a Load

Travel with load or carriage as low as possible and tilted back. Never travel with the load or carriage raised (elevated) in a high position. Do not elevate the load except during stacking.

Observe all traffic regulations and watch for other traffic, pedestrians, and safe clearances. Always look in the direction of travel. Keep a clear view of the path of travel, and when the load blocks your visibility, travel in reverse with load trailing (except when climbing an incline).

Avoid sudden movements when carrying a load—start, stop, travel, steer, and brake smoothly. Steer clear of bumps, holes, and loose materials or debris on the ground. Lift and tilt slowly and smoothly. Go slowly when turning. Cross railroad tracks slowly at an angle wherever possible.

Use special care when handling and traveling with long, high, or wide loads—to avoid losing the load, striking bystanders or obstructions, or tipping the truck.

Watch clearances around the truck and load as you travel. Raise the forks or attachment only to pick up or stack a load. Look out for obstructions, especially overhead.

Be aware that exaggerated tail swing, when turning while traveling forward, is a characteristic of lift trucks that are steered by the rear wheels. Accordingly, you need to become accustomed to tail swing and always check the tail swing area of the counterweight to be sure it is clear before you turn.

Always be concerned about the stability of your lift truck. When attachments are used, extra care should be taken in securing, manipulating, positioning, and transporting the load. Because attachments generally add extra weight and complexity to the truck, operate trucks equipped with attachments as partially-loaded trucks when not handling a load.

Picking Up and Moving Loads

When picking up a load from the ground, approach the load slowly and carefully align the truck square with the load. The forks should be adjusted to fit the load or pallet being handled and spread as wide as possible to provide good stability and balance. Before lifting, be sure the load is centered and the forks are fully under and supporting the load. Fork length should be at least $\frac{2}{3}$ of load length. With the lift and tilt controls, adjust the forks to the correct height and angle for freely engaging the load pallet. Move forward until the forks are squarely and completely under the load.

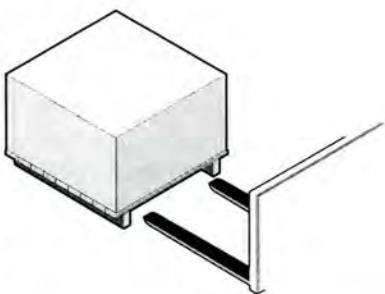

NOTICE

Be sure that the forks do not extend beyond the load, causing damage or tipping of other adjacent loads or materials behind the load being moved.

If the forks are longer than the load, move the tips partially under the load without extending beyond the load. Raise the load to clear the floor. Back out several inches, or whatever distance is necessary, then set the load down and move forward until the load is positioned against the carriage.

Raise the load from the floor or stack by tilting the upright back just enough to lift the load from the surface. When stacking or tiering, use only enough backward tilt to stabilize the load.

Then raise the load to traveling height and tilt fully back to travel (except for loads that must be transported as level as possible).

Unloading

To deposit a load on the floor after being moved into the correct position, tilt the upright forward to a vertical position and lower the load.

Adjust the fork height and tilt the upright forward slightly, as necessary, for smooth removal of the forks from the load (pallet).

Carefully back away to clear the forks from the load.

Raise the forks to traveling height and tilt fully back.

Stacking

To put a load on a stack:

1. Approach slowly and align the lift truck and load squarely with the stack.
2. Raise (elevate) the load as the lift truck is nearing the stack.
3. Move forward, slowly, until the load is almost touching the stack. The leading edge and sides of the load pallet should be lined up exactly with the near edge and side of the load or rack on which you are stacking.
4. Stop close to the stack and further lift (raise) the load high enough to clear the top surface of the stack. Slowly move the load into position. Be careful not to damage or move adjacent loads.
5. When the load is aligned with the stack beneath it, tilt the upright to the vertical position and carefully lower the load onto the top surface of the stack.

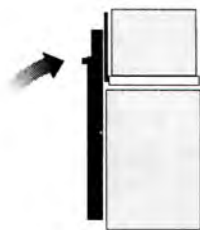
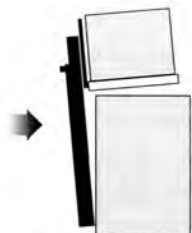
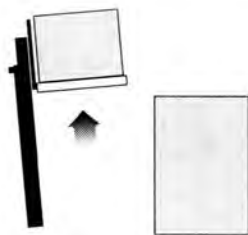
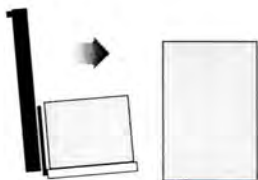

- Lower (drop) the forks slightly to clear (disengage) the load pallet. Tilt the forks forward slightly, if necessary.

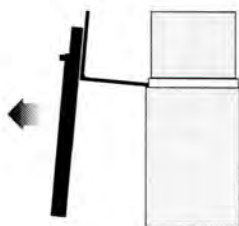

- Check your travel path, then carefully back away until the forks are clear of the stack. Stop and lower the forks to the travel position (6 to 8 inches above the ground), then tilt back to travel.

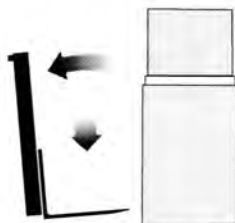

To move a load from a stack:

Approach the stack carefully, truck lined up squarely with the load. With the truck just in front of the stack and the upright mast vertical, raise the forks to the correct height for freely engaging the load pallet. Adjust fork angle as necessary to fit squarely under the load. Move forward until the forks are under the load.

Be sure that the forks do not extend beyond the load, causing damage or tipping of other adjacent loads or materials behind the load being moved. If the forks are longer than the load, move the tips partially under the load without extending beyond the load. Raise the load to clear the undersurface. Back out several inches, then set the load down and move forward until the front face of the forks contacts the load.

Raise the load from the stack by tilting the upright back just enough to lift the load from the surface. Or, with the mast still vertical, raise the forks until they begin to lift the load. At this point, apply the minimum back tilt that will stabilize the load.

Check your travel path, slowly back off until clear of the stack, stop, and then lower the load to the travel position (6 to 8 inches off the ground). Tilt full back to travel (except for certain loads that may have to be transported as level as possible). Be sure the load is back flush against the carriage or front face of the forks.

NOTICE

Certain loads may have to be transported as level as possible.

After Operating the Truck

Always leave your lift truck in a safe condition. When you leave your truck, or park it, follow these safety rules:

- Park in a safe area away from normal traffic.
- Never park on a grade.
- Never park in areas that block emergency routes or equipment, access to fire aisles, or stairways and fire equipment.

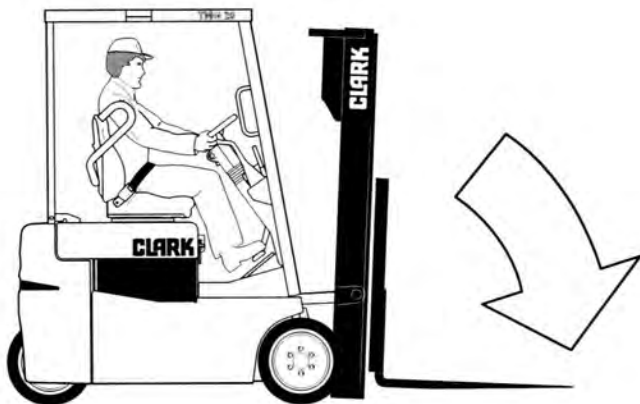

Before leaving the operator's position:

1. Bring truck to complete stop.
2. Put the directional control lever in the NEUTRAL position.
3. Apply the parking brake.
4. Lower the lifting mechanism—carriage and forks or attachment—fully to the floor.

In addition, when leaving the truck unattended:

5. Tilt the upright forward until the forks are level and flat on the floor.
6. Turn the key switch to the OFF position.
7. Block the wheels if the truck must be left on an incline or you have any doubt about the truck moving from a safe position.

Emergency Towing

Contents

Towing Precautions	6-2
Towing Procedures	6-2

Towing Precautions

If your lift truck becomes disabled but can be moved freely on its own wheels without further damage, use the following procedures to tow it safely to a repair area. It is important for your safety and to the care of your lift truck to use the proper equipment and carefully follow these recommendations for safe towing.



WARNING

DO NOT tow a lift truck if there is a problem with the brakes or tires, or the steering cannot be operated.

DO NOT tow up or down ramps and steep inclines.

DO NOT attempt to tow a lift truck if traction or weather conditions are poor.

DO NOT tow with truck in either "Forward" or "Reverse". Always tow with the truck in "Neutral"

Towing Procedures

1. Be sure to apply the parking brake or block the drive wheels on the disabled truck while working around it.
2. If possible, raise the carriage (forks) on the disabled truck about 12 inches (300 mm) from the floor. Secure the carriage with a chain.
3. Obtain another lift truck of equal or larger size for towing. It should be partially loaded, for traction.
4. Use an approved solid metal tow bar with towing couplers that connect to the towing pin in the counterweight or that connect to the frame or chassis through the counterweight of each truck.
5. Check that the counterweight bolts are in place and properly torqued. (The counterweight bolts are made of special high tensile steel and are not commercially available. Replace, when necessary, only with genuine Clark replacement part).
6. Tow the disabled truck backwards. **An operator must be on the towed truck wearing a seat belt.**

Tow the truck slowly. Careful towing is necessary to prevent injury to personnel or damage to the truck. The truck should be towed in neutral and at a speed of less than 5 mph (8 kph) with a driver in the seat. Do not lift the truck or any wheels off the floor while the truck is being towed.

**CAUTION**

The power steering does not operate on the disabled truck when the power steer motor is not running, which makes the steering handwheel difficult to turn.

7. Park the disabled truck in authorized areas only. Fully lower the forks to the floor, put directional control lever in the NEUTRAL position and turn the key switch to the OFF position. Engage the parking brake. Disconnect the battery. Remove the key and, when necessary, block the wheels to prevent the truck from rolling.

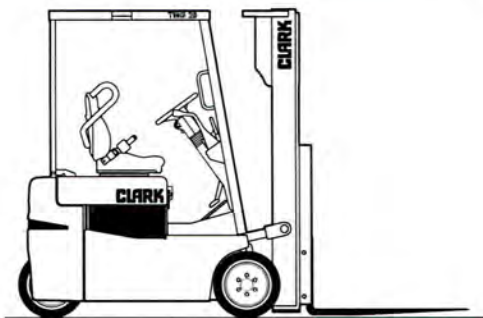
LIFT TRUCK PARKING**WARNING**

Always engage the parking brake when parking a lift truck. The truck can move and cause injury or death to personnel near it.

Handwritten text at the top of the page, partially cut off.

Planned Maintenance

Contents

Planned Maintenance	7-2
Lift Truck Maintenance	7-2
Planned Maintenance Intervals	7-3
Daily Maintenance Checks	7-4
Periodic Maintenance Checks	7-5
Safe Maintenance Practices	7-6
PM Report Form	7-10
Visual Inspection	7-11
Functional Tests	7-14
Checking the Hydraulic Fluid	7-19
Critical Fastener Checks	7-19
Air Cleaning the Truck	7-20
Electric Truck Battery Maintenance	7-21
Battery Handling	7-22
Battery Charging	7-23
Battery Removal from Truck	7-24
Battery Cleaning and Care	7-25
Battery Service Records	7-25
How to Get Maximum Battery Life	7-26
Battery Installation	7-26

Lift Truck Maintenance

Regular maintenance and care of your lift truck is not only important for full and efficient truck life; it is essential for your safety. The importance of maintaining your lift truck in a safe operating condition by servicing it regularly and, when necessary, repairing it promptly cannot be emphasized too strongly. Experience has shown that powered industrial trucks can cause injury if improperly used or maintained. In the interest of promoting safety, several current industry and government safety standards specify that any powered industrial truck not in safe operating condition be removed from service and that all repairs be made by trained and authorized persons.

To assist you in keeping your lift truck in service and in good operating condition, this section outlines maintenance procedures that should be done at regular intervals. This planned approach is considered essential to the life and safe performance of your truck.

It is your responsibility to be alert for any indication that your truck may need service and have it attended to promptly. You play an important part in maintenance. Only you can make sure that your lift truck regularly receives the care it needs.



CAUTION

Powered industrial trucks may become hazardous if maintenance is neglected.

Planned Maintenance

As outlined previously, you should always make a safety inspection of your lift truck before operating it. The purpose of this daily examination is to check for any obvious damage and maintenance problems, and to have minor adjustments and repairs made to correct any unsafe condition.

In addition to the daily inspection, CLARK recommends that you set up and follow a periodic planned maintenance (PM) and inspection program. PM inspections should only be performed by a trained and authorized fork lift mechanic. Performed on a regular basis, the program provides thorough inspections and checks on the safe operating condition of your lift truck. The need for major adjustments, repairs, or replacements is found and corrections made as required, not after failure has occurred. The specific schedule (frequency) for these PM inspections depends on the conditions of your particular application and lift truck usage.

The recommended planned maintenance and lubrication schedule lists those items considered essential to the safety, life, and performance of your truck with typical recommended service intervals. Brief procedures for inspections, operational checks, cleaning, lubrication, and minor adjustments are included for your reference.

Your local CLARK dealer is prepared to help you with your Planned Maintenance Program, if you want assistance. Your CLARK dealer has specially trained service personnel who are authorized to check your lift truck according to the applicable safety regulations.

"Section 8, Specifications," contains some useful information for selected components, fuel and lubricants, critical bolt torques, refill capacities, and settings for your truck.

If you have the need for more information on the care and repair of your truck, see your CLARK dealer.

Planned Maintenance Intervals

Typical Operating Conditions

Time intervals between maintenances are largely determined by operating conditions. For example, operation in sandy, dusty locations requires shorter maintenance intervals than operation in clean warehouses. The indicated intervals are intended for **normal** operation. The following operating conditions are defined:

Normal Operation: Basically, eight-hour material handling, mostly in buildings or in clean, open air on clean paved surfaces.

Severe Operation: Prolonged operating hours or constant usage.

Extreme Operation:

- In sandy or dusty locations, such as: cement plants, lumber mills, and coal dust or stone crushing sites
- High-temperature locations, such as: steel mills, foundries, etc.
- Sudden temperature changes, such as: constant trips from buildings into the open air, refrigeration plants, etc..

If your fork lift truck is used in severe or extreme operating conditions, you must shorten the maintenance intervals accordingly.

NOTICE

Since the operating environment of lift trucks varies widely, the above descriptions are highly generalized and should be applied as actual conditions dictate.

Daily Maintenance Checks

Recommended PM Intervals

The maintenance time intervals referred to in this manual relate to truck operating hours as recorded by the diagnostic system (or hourmeter) and based on experience which CLARK has found to be convenient and suitable under typical (normal or average) operating conditions, as follows:

A = 8-10 hours or daily

B = 50-250 hours or every month

C = 450-500 hours or every 3 months

D = 900-1000 hours or every 6 months

E = 2000 hours or every year

DAILY MAINTENANCE CHECKS	A	B	C	D	E
Check truck for obvious damage and leaks.	•				
Check/clean battery terminals.	•				
Check electrolyte level.	•				
Check capacity, warning plates and decals.	•				
Check condition of tires and wheels, remove embedded objects.	•				
Check wheel lug nuts.	•				
Check hydraulic sump oil level.	•				
Check gauges and instruments.	•				
Check warning lights and hour meter.	•				
Check overhead guard condition and bolts.	•				
Check horn operation and other warning devices.	•				
Check steering operation.	•				
Check service brake operation.	•				
Check parking brake operation.	•				
Check directional and speed control operation.	•				
Check accelerator.	•				
Check lift, tilt and auxiliary operation.	•				
Check upright, lift chains and fasteners.	•				
Check load backrest extension and forks.	•				

Periodic Maintenance Checks

PM Interval:

A = 8-10 hours or daily

B = 50-250 hours or every month

C = 450-500 hours or every 3 months

D = 900-1000 hours or every 6 months

E = 2000 hours or every year

Notes:

* Replace as required.

PERIODIC CHECKS and PLANNED MAINTENANCE (PM)	A	B	C	D	E
Check truck visually and inspect components.	•				
Test drive truck/check functional performance.	•				
Air clean truck.	•				
Check torque on critical fasteners.	•				
Lubricate truck. (See component)					
Clean/check battery terminals, electrolyte level.	•				
Check battery cables/truck receptacle.	•				
Perform battery load test.	•				
Check drive motor brushes.*	•				
Check lift motor brushes.*	•				
Check steer motor brushes.*	•				
Test ground.	•				
Clean drive axle air vent.	•				
Check drive axle fluid level.	•				
Drain and replace drive axle fluid.					•
Check brake condition and wear.				•	
Check drive axle mounting and fasteners.				•	
Lubricate steer axle linkage.	•				
Check/lubricate steer axle wheel bearings.					•
Replace hydraulic sump fluid and filter.					•
Clean/replace hydraulic sump breather.				•	
Lubricate tilt cylinder rod ends.	•				
Check lift chain adjustment and wear.	•				
Check/lubricate lift chains.	•				
Lubricate upright rollers.	•				

Safe Maintenance Practices

The following instructions have been prepared from current industry and government safety standards applicable to industrial truck operator and maintenance. These recommended procedures specify conditions, methods, and accepted practices that aid in the safe maintenance of industrial trucks. They are listed here for the reference and safety of all workers during maintenance operations. Carefully read and understand these instructions and the specific maintenance procedures before attempting to do any repair work. When in doubt of any maintenance procedure, please contact your local CLARK dealer.

1. Powered industrial trucks can become hazardous if maintenance is neglected. Therefore, suitable maintenance facilities, trained personnel, and procedures shall be provided.
2. Maintenance and inspection of all powered industrial trucks shall be done in conformance with the manufacturer's recommendations.
3. A scheduled planned maintenance, lubrication, and inspection system shall be followed.
4. Only trained and authorized personnel shall be permitted to maintain, repair, adjust, and inspect industrial trucks—and in accordance with the manufacturer's specifications.
5. Properly ventilate work area, and keep shop clean and floor dry.
6. Avoid fire hazards and have fire protection equipment present in the work area. Do not use an open flame to check fluid or electrolyte levels. Do not use open pans of fuel or flammable cleaning fluids for cleaning parts.
7. Before starting work on truck:
 - a. Raise drive wheels free of floor and use blocks or other positive truck positioning devices.
 - b. Put blocks under the load-engaging means, innermasts, or chassis before working on them.
 - c. Disconnect battery before working on the electrical system.

NOTICE

Refer to the "Jacking and Blocking" section in the Service Manual for proper procedures.

8. Operation of the truck to check performance must be conducted in an authorized, safe, clear area.

9. Before starting to drive the truck:
 - a. Be seated in operating position.
 - b. Make sure parking brake is applied.
 - c. Put directional control in NEUTRAL.
 - d. Turn the key switch to the ON position.
 - e. Release the parking brake.
 - f. Check functioning of lift and tilt systems, directional and speed controls, steering, brakes, warning devices, and any load handling attachments.

10. Before leaving the truck:
 - a. Stop truck.
 - b. Fully lower the load-engaging means; upright, carriage, forks or attachments. Tilt upright forward.
 - c. Put directional control in neutral.
 - d. Apply the parking brake.
 - e. Turn the key switch to the OFF position.
 - f. Disconnect battery.
 - g. Put blocks at the wheels if truck must be left on an incline.

11. Brakes, steering mechanisms, control mechanisms, warning devices, lights, lift overload devices, lift and tilt mechanisms, articulating axle stops, and frame members must be carefully and regularly inspected and maintained in a safe operating condition.

12. Special trucks or devices designed and approved for hazardous area operation must receive special attention to insure that maintenance preserves the original approved safe operating features.

13. All hydraulic systems must be regularly inspected and maintained in conformance with good practice. Tilt and lift cylinders, valves, and other parts must be checked to assure that "drift" or leakage has not developed to the extent that it would create a hazard.

14. When working on hydraulic system, be sure the battery is disconnected, upright is in the fully-lowered position, and hydraulic pressure is relieved in hoses and tubing. Do not check for hydraulic leaks with bare hands.

**WARNING**

Always put blocks under the carriage and upright rails when necessary to work with upright in an elevated position.

-
15. The truck manufacturer's capacity, operation, and maintenance instruction plates, tags, or decals must be maintained in legible condition.
 16. Batteries, limit switches, protective devices, electrical conductors, and connections must be maintained in conformance with good practice. Special attention must be paid to the condition of electrical insulation.
 17. To avoid injury to personnel or damage to the equipment, consult the manufacturer's procedures in replacing contacts on any battery connection.
 18. Industrial trucks must be kept in a clean condition to minimize fire hazards and help in detection of loose or defective parts.
 19. Modifications and additions that affect capacity and safe truck operation must not be done without the manufacturer's prior written approval. Capacity, operation, and maintenance instruction plates, tags, or decals must be changed accordingly.
 20. Care must be taken to assure that all replacement parts, including tires, are interchangeable with the original parts and of a quality at least equal to that provided in the original equipment. Parts, including tires, are to be installed per the manufacturer's procedures. Always use genuine CLARK or CLARK-approved parts.
 21. Use special care when removing heavy components from the truck, such as counterweight, upright, etc., the truck can become unstable and tipover. Be sure that lifting and handling equipment is of correct capacity and in good condition.

NOTICE

You should also be familiar with additional operating and maintenance safety instructions contained in the following publications:

ANSI/ASME B56.1: Safety Standard for Low Lift and High Lift Trucks (Safety Code For Powered Industrial Trucks). Published by: Society of Mechanical Engineers, United Engineering Center, 345 E. 47th Street, New York, NY 10017.

NFPA 505-1982: Fire Safety Standard for Powered Industrial Trucks: Type Designations, Areas of Use, Maintenance and Operation. Available from National Fire Protection Assoc., Inc., Batterymarch Park, Quincy, MA 02269.

General Industrial Standards, OSHA 2206: OSHA Safety and Health Standards (929 CFR 1910), Subpart N-Materials Handling and Storage, Section 1910.178 Powered Industrial Trucks. For sale by: Superintendent of Documents, U.S. Government Printing Office, Washington, DC, 20402.

IMPORTANT

Your new CLARK lift truck has been built to meet all applicable mandatory requirements of ANSI B56.1 Safety Standard for Powered Industrial Trucks. Each truck also includes certain safety devices, e.g., horn and overhead guard, as standard equipment.

No additions, omissions, or modifications should be made that affect compliance to the above requirements or in any way minimize the effectiveness of the safety devices.

PM Report Form

A planned maintenance (PM) program of regular, routine inspections and lubrication is important for long life and trouble-free operation of your lift truck. Make and keep records of your inspections. Use these records to help establish the correct PM intervals for your application and to indicate maintenance required to prevent major problems from occurring during operation.

As an aid in performing and documenting your PM inspections, CLARK prepared an ***Electric Truck Planned Maintenance Report Form*** (PM Report Form). Copies of this form may be obtained from your authorized CLARK dealer. We recommend that you use this form as a checklist and a record of your inspection and truck condition.

The maintenance procedures outlined in this manual are intended to be used in conjunction with the PM Report Form. They are arranged in groupings of maintenance work that are done in a logical and efficient sequence.

You make check marks or entries on the PM Report Form when you perform the PM. Please notice on the form a special coding system for indicating the importance of needed repairs and/or adjustments.

When you have finished the PM inspections, be sure to give a copy of the report to the designated authority responsible for lift truck maintenance.

Do not make repairs or adjustments unless authorized to do so.

For safety, it is good practice to:

- Remove all jewelry (watch, rings, bracelets, etc.) before working on the truck.
- Disconnect the battery before working on electrical components.
- Always wear safety glasses. Wear a safety (hard) hat in industrial plants and in special work areas where protection is necessary and required.

Visual Inspection

Begin the PM routine with a visual inspection of the lift truck and its components.

1. Walk around the truck and take note of any obvious damage and maintenance problems. Check for loose fasteners and fittings.
2. Check to be sure all capacity, safety, and warning plates or decals are attached and legible.

NOTICE

NAMEPLATES AND DECALS: Do not operate a lift truck with damaged or lost decals and nameplates. Replace them immediately. They contain important information.

3. Inspect the truck for any sign of external leakage: transmission fluid, etc..
4. Check for hydraulic oil leaks and loose fittings.



CAUTION

HYDRAULIC FLUID PRESSURE: Do not use your hands to check for hydraulic leakage. Fluid under pressure can penetrate your skin and cause serious injury.

5. Be sure that the driver's overhead guard, load backrest extension, and safety devices are in place, undamaged, and attached securely.

Then check all of the critical components that handle or carry the load.

Overhead Guard

Check the overhead guard for damage. Be sure that it is properly positioned and all mounting fasteners are in place and tight. Make sure no cracks have developed.

Upright Assembly

Inspect the upright assembly: rails, carriage rollers, lift chains, and lift and tilt cylinders. Look for obvious wear and maintenance problems, damaged or missing parts.

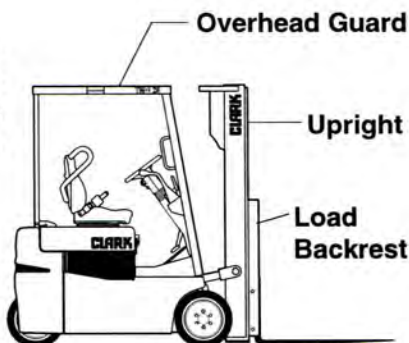

IMPORTANT

Make sure that no structural members have developed any cracks.

Check for any loose parts or fittings. Check for leaks, any damaged or loose rollers, and rail wear (metal flaking). Inspect all lift line hydraulic connections for leaks

Load Backrest

Check the load backrest for damage. Inspect the welds on the carriage and load backrest for cracks. Be sure that the mounting fasteners are all in place and tight.

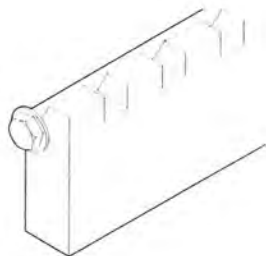

If the load backrest extension has been removed, a bolt and washer must be in place on each end of the top fork bar to act as a fork stop.

Lift Chain

Carefully check the lift chains for wear, rust, and corrosion, cracked or broken links, stretching, etc.. Check that the lift and carriage chains are adjusted to have equal tension. See SM612 for proper chain adjustment and checks. Check that the lift chain anchor fasteners and locking means are in place and tight.



Uprights and lift chains require special attention to maintain them in safe operating condition.

- **Uprights can drop suddenly. Look at the upright, but keep hands out.**
- **Lift chain repairs and adjustments should be made by trained service personnel.**

Forks

Inspect the load forks for cracks, breaks, bending and wear. The fork top surfaces should be level and even with each other. The height difference between both fork tips should be no more than 3% of the fork length.



WARNING

If the fork blade heel is worn down by more than 10 per cent, the load capacity is reduced and the fork must be replaced.

10% of "A" is max. wear

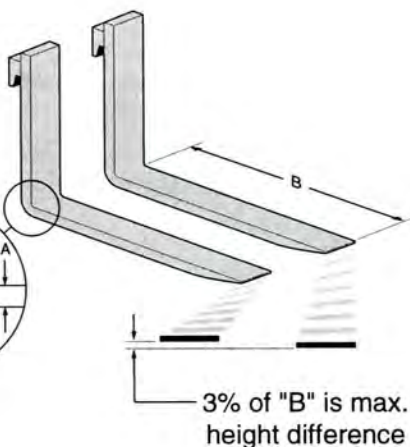
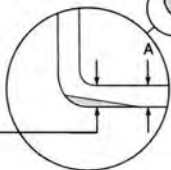

Inspect the forks for twists and bends. Put a 2"-thick metal block, at least 4" wide by 24" long, on the blade of the fork with the 4" surface against the blade. Put a 24" carpenter's square on the top of the block and against the shank. Check the fork 20" above the blade to make sure it is not bent more than 1" maximum.

If the fork blades are obviously bent or damaged, have them inspected by a trained maintenance person before operating the truck.

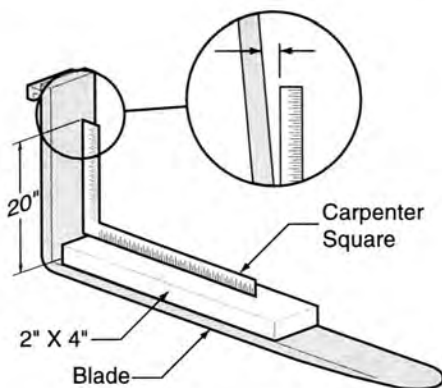

Inspect the fork latches. Be sure they are not damaged or broken and operate freely and lock correctly. Check the fork stop pins for secure condition.

Wheels and Tires

Check the condition of the drive and steer wheels and tires. Remove objects that are embedded in the tire. Inspect the tires for excessive wear and breaks or "chunking out" and bond failure between the tire and the rim.

Check all wheel lug nuts or bolts to be sure none are loose or missing.

Have missing bolts replaced and loose bolts tightened to the correct torque before operating truck.



Functional Tests

Now, check that all controls and systems are functioning correctly. Test horn, lights, and all other safety equipment and accessories. Be sure they are properly mounted and working correctly.

Press the horn button to check horn function. If the horn or any other part does not operate, report the failure, and have it repaired before the truck is put into operation.

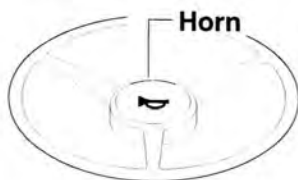

Service and Parking Brakes

Operate service and parking brakes; all hydraulic controls—lift, tilt, and auxiliary (if installed); accelerator; directional controls; and steering system. Be sure all controls operate freely and return to neutral properly.

Check the service brake system. Push the brake pedal fully down and hold. The brakes should be applied before the pedal reaches the floorplate. Check for a feeling of solid resistance when the pedal stops. The pedal must feel firm and not move down farther after it stops. If the pedal continues to creep downward, report the failure immediately. Do not operate the truck until the brakes are repaired.

Check the function of the parking brake. Release, then apply the parking brake with the lever. When correctly adjusted, the lever should snap-lock easily into the over-center applied position.

To check parking brake holding capability and adjustment, park the lift truck on a grade and apply the parking brake. The parking brake should hold a lift truck with rated load on a 15% grade. When the lever is released, the brakes should not drag.

Lift Mechanisms and Controls

Check the function of the lift system and controls.

Pull back on the tilt control lever and hold until the upright reaches the full back tilt position. Push forward on the lever to return the upright to the vertical position. Release the lever. It should spring back to the neutral position freely without assistance.

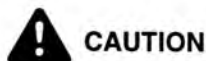

Be sure that there is adequate overhead clearance before raising the upright.

Pull back on the lift control lever and raise the fork carriage to full height. Watch the upright assembly as it rises. All movements of the upright, fork carriage, and lift chains must be even and smooth, without binding or jerking. Watch for chain wobble or looseness; the chains should have equal tension and move smoothly without noticeable wobble. Release the lever. It should spring back to the center position.

If the maximum fork height is not reached, this indicates there is an inadequate (low) oil level in the hydraulic sump tank or severe binding within the upright.

Push forward on the lift control lever. Watch the upright as it lowers. Movement should be smooth and even. When the forks reach the floor, release the lever. It should spring back to the center position.

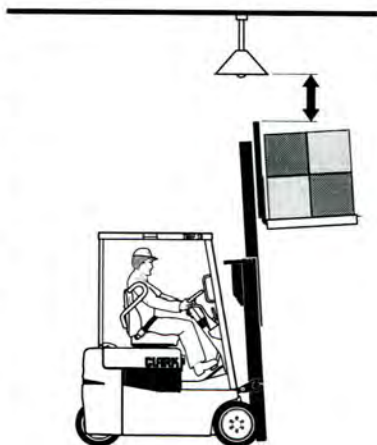

Auxiliary Controls

If your lift truck is equipped with an attachment, test the control lever for correct function and briefly operate the attachment.

Steering System

NOTICE

The steering system, steer axle, and steering linkage on your truck should be inspected periodically for abnormal looseness and damage, leaking seals, etc.. Also, be alert for any changes in steering action. Hard steering, excessive freeplay (looseness), or unusual sound when turning or maneuvering indicates a need for inspection or servicing.

Check the steering system by moving the steering handwheel in a full right turn and then in a full left turn. Return the handwheel (steer wheels) to the straight-ahead position. The steering system components should operate smoothly when the steering wheel is turned.



IMPORTANT

Never operate a truck with a steering system fault.



WARNING

Fasten your seat belt before driving the truck.

Direction Control and Brakes

Check and make sure that the travel area is clear in front of the truck. Push firmly on the brake pedal. Release the parking brake. Move the direction control lever from NEUTRAL to FORWARD travel position.

Remove your right foot from the brake pedal and put it on the accelerator pedal. Push down until the truck moves slowly forward. Remove your foot from the accelerator pedal and push down on the brake pedal to stop the truck. The brakes should apply smoothly and equally. Be sure the travel area is clear behind the truck.

Put the directional control lever in the REVERSE travel position. Push down on the accelerator pedal until the truck moves slowly in the reverse direction. Remove your foot from the accelerator pedal and push down on the brake pedal to stop the truck. The brakes should apply smoothly and equally.

Transistorized Traction Control

Test for correct function of the traction control. Check creep speed and plugging.



CAUTION

Check and make sure the travel area is clear before each movement and before each change of direction.

1. Check creep speed and while driving the truck in a straight line in both forward and reverse directions. All speed changes should be smooth while increasing and decreasing speed. Notice any unusual drive train noise or action of the controls and drive train components.

Stop the truck with the service brakes. Note any unusual reactions in driving or braking performance. Note any need for adjustment.

2. Check the plugging function first at a slow speed. If operating correctly then test at full speed.

First drive the truck in the FORWARD direction. Push the accelerator pedal and allow the truck to accelerate to the desired travel speed. Then, move the direction control to the REVERSE position while your foot is still depressing the accelerator pedal. The truck should slow to a smooth, controlled stop and accelerate in the opposite direction.

Repeat the test by moving the direction control back to the forward position.

Check the accelerator control while conducting the speed range tests. It must move easily and smoothly throughout the acceleration stroke and return without binding.

Test the service brake (drive motor cut-off) switch.

Drive the truck in FORWARD (or in REVERSE) at creep speed. While holding the accelerator pedal steady, push on the brake pedal with your left foot. The braking action should interrupt power to the drive motor and stop the truck. Release the brake pedal. The drive motor should start moving the truck again.

IMPORTANT

When you have completed the operational tests, park and leave the truck according to standard shut down procedures.

Be sure to make a record of all maintenance and operating problems you find.

Checking the Hydraulic Fluid

Check the hydraulic sump tank fluid level. Correct fluid level is important for proper system operation. Low fluid level can cause pump damage.

Hydraulic fluid expands as its temperature rises. Therefore, it is preferable to check the fluid level at operating temperature (after approximately 30 minutes of truck operation). To check the fluid level, first park the truck on a level surface and apply the parking brake. Put the upright in a vertical position and lower the fork carriage fully down. Pull the dipstick out (under the sump breather), wipe it with a clean wiper, and reinsert it. Remove dipstick and check oil level. Keep the oil level above the LOW mark on the dipstick by adding recommended hydraulic fluid only, as required. **Do not overfill.**

IMPORTANT

When checking hydraulic oil, make sure you use a clean wiper and do not let contaminants get on the dipstick or in the sump.

Check the condition of the hydraulic fluid (age, color or clarity, contamination). Change (replace) the oil as necessary

Critical Fastener Checks

Fasteners in highly loaded (critical) components can quickly fail if they become loosened. Also, loose fasteners can cause damage or failure of the component. For safety, it is important that the correct torque be maintained on all critical fasteners of components that directly support, handle, or control the load and protect the operator. Check critical items, including:

- Drive axle mounting
- Drive and steer wheel mounting
- Counterweight mounting
- Load backrest extension
- Overhead guard
- Tilt cylinder mounting & yokes
- Upright mounting & components

Air Cleaning the Truck

Always maintain a lift truck in a clean condition. Do not allow dirt, dust, lint, or other contaminants to accumulate on the truck. Keep the truck free from leaking oil and grease. Wipe up all oil spills. Keep the controls and floorboards clean, dry, and safe. A clean truck makes it easier to see leakage and loose, missing, or damaged parts. A clean condition helps prevent fires and helps the truck run cooler.

The environment in which a lift truck operates determines how often and to what extent cleaning is necessary. For example, trucks operating in manufacturing plants with a high level of dirt, dust, or lint, (e.g., cotton fibers, paper dust, etc.) in the air or on the floor require more frequent cleaning. If air pressure does not remove heavy deposits of grease, oil, etc., it may be necessary to use steam or liquid spray cleaner.

IMPORTANT

Do not steam or use liquid spray cleaner on motor control panel.

Lift trucks should be air cleaned at every PM interval, and more often if needed.

Use an air hose with special adapter or extension having a control valve and nozzle to direct the air properly. Use clean, dry, low-pressure compressed air. Restrict air pressure to 30 psi (207 kPa), maximum (OSHA requirement).



CAUTION

Wear suitable eye protection and protective clothing.

Air clean: upright assembly; drive axle; battery; cables; switches and wiring harness; transistor traction controls and wiring; drive, lift, and steer motors; and steer axle, steer cylinder, and linkage.

Electric Truck Battery Maintenance

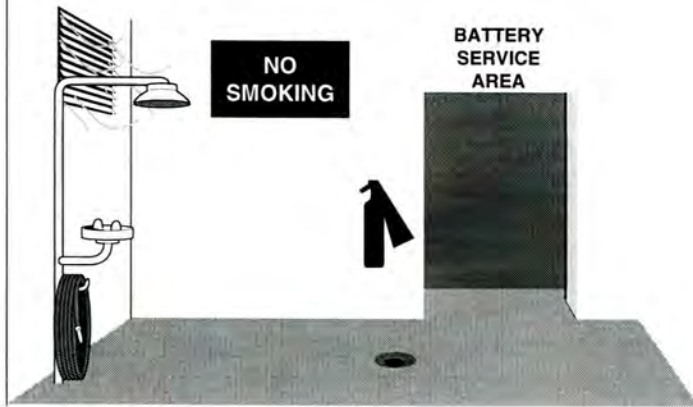

Battery charging installations must be located in areas designated for that purpose. These areas must be kept free of all non-essential combustible materials.

Facilities must be provided for:

- Flushing spilled electrolyte
- Eye wash facility
- Fire protection
- Protecting charging apparatus from damage by trucks
- Adequate ventilation for dispersal of fumes from gassing batteries.

When handling acid concentrates greater than 50 percent acid (above 1.400 specific gravity), an eye wash fountain must be provided.

A conveyor, overhead hoist, or equivalent material handling equipment must be provided for handling batteries.

IMPORTANT

Electric truck batteries are heavy and awkward to handle. They are filled with a very hazardous chemical solution. On charge, they give off hydrogen and oxygen which, in certain concentrations, are explosive. And they are costly. Before you remove, service, or install a truck battery, carefully read the following recommendations and instructions.

Battery Handling

1. Change (remove) or service storage batteries only in an area designated for this purpose.
2. Be sure this area has provisions to flush and neutralize spillage, to ventilate fumes from gassing batteries, and for fire protection.
3. This area should be equipped with material-handling tools designed for removing and replacing batteries, including a conveyor or overhead hoist. Use lift hooks that have safety latches.
4. Always use a special lifting device such as an insulated spreader bar to attach the hoist to the battery. The width of the spreader bar hooks must be the same as the lifting eyes of the battery, to prevent damage to the battery. If the spreader bar hooks are movable, carefully adjust the position (width) of the hooks so that the pull is directly upward (vertical) and no side load or force (pressure) is exerted on the battery case. Be sure the lift hooks are the correct size to fit the lifting eyes of the battery.
5. If the battery does not have a cover of its own or has exposed terminals and connectors, cover the top with a non-conductive (insulating) material, e.g., a sheet of plywood or heavy cardboard, prior to attaching the lifting device.
6. Chain hoists or power battery hoists must be equipped with load-chain containers to accumulate the excess lifting chain.

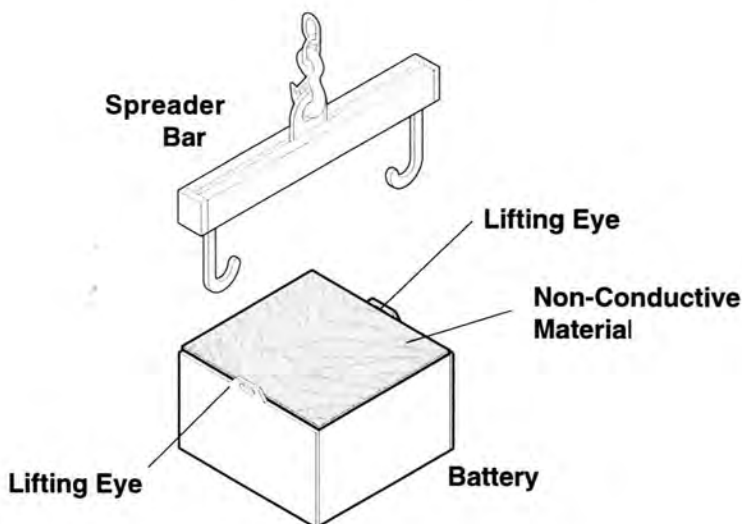

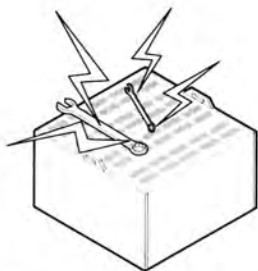

7. Keep all tools and other metallic objects away from the terminals.



WARNING

BATTERY SERVICE: Battery service must be done by trained and authorized personnel. Battery acid can cause severe burns and injury.

Battery Charging

1. Persons maintaining storage batteries must wear protective clothing such as face shield, long sleeves, and gloves.
2. Hydrogen emissions from charging batteries are flammable. No smoking is allowed in the charging area. Do not check the electrolyte level with an open flame. Do not allow open flame, sparks, or electric arcs in battery charging area.



WARNING

SULFURIC ACID: The battery contains corrosive acid that can cause injury. If acid contacts your eyes or skin, flush immediately with water and get medical assistance.



WARNING

EXPLOSIVE GASES: Do not smoke or have open flames or sparks on battery charging areas or near batteries. An explosion can cause injury or death.

3. When charging batteries, the vent caps must be kept in place to avoid electrolyte spray. Care must be taken to assure that vent caps are open (clean) and functioning. The battery (or compartment) cover(s) must be open to dissipate heat and gas.

IMPORTANT

If batteries discharge rapidly during normal operation or do not charge to the correct specifications, contact a qualified battery service technician to check the battery for you. Do not add electrolyte or attempt to service the battery.

Battery Removal from Truck

1. Check the designated service and charging area for fire protection, and be sure all sources of ignition are cleared from the area. **Do not smoke.** Be sure all previous noted equipment is in the area, in good repair, and working properly. If the battery is to be serviced, be sure there are provisions to flush and neutralize spillage and to disperse (ventilate) fumes from gassing batteries on charge. And, be sure there are provisions for handling electrolyte.
2. Before attempting to remove or charge a storage battery, the truck should be positioned in the designated battery service area and the parking brake applied so the truck cannot move.
3. If the battery to be handled is not equipped with its own cover, cover the battery when handling with a non-conductive (insulating) material, e.g., plywood or heavy cardboard, before attaching the lifting device.
4. Use an approved lifting device with an insulated spreader bar, to remove and transport a truck battery. Be sure the hoist and lifting chains are equipped with safety hooks.
5. Remove the battery and move it to a safe storage location. Store batteries either on an approved battery rack or on a wooden pallet.

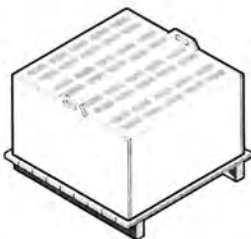

Battery Cleaning and Care

Never wash the battery when it is in the truck. The easiest and most satisfactory method of cleaning a battery is to wash it occasionally with a low-pressure cold-water spray. The top can also be washed off with a solution of baking soda and water (add a box of baking soda to a pail of water and stir until dissolved) and rinsed with clean water. It is good practice to have this solution in a battery room at all times.

IMPORTANT

During cleaning, the battery vent caps must be tightly in place.

Refer to the battery manufacturer or supplier for their recommended battery maintenance and care procedures.

BATTERY SAVER and CLEANER, CLARK Part No. 886398, may be used to clean and protect the truck battery.

New Truck Batteries: Apply a light coat of BATTERY SAVER and CLEANER to entire surface of battery. Allow to set for approximately 30 seconds, then wipe thoroughly with a wiping cloth or rag. Chemical action will dissolve rust and corrosion. After cleaning, apply a second coating for protection. This will prevent the start and growth of corrosion on battery terminals and cable connections.

Battery Service Records

Keep a record of battery service and maintenance to obtain the best service life from your battery and truck. Select a pilot cell, take readings of specific gravity and temperature before and after charging, and record the readings with the date. It is best to change the location of the pilot cell occasionally to distribute any electrolyte loss over the battery. Every 2 or 3 months, take complete battery readings (specific gravity, temperature, and voltage) and make a record of them.

How to Get Maximum Battery Life

1. Follow normal battery maintenance procedures, re-charging before 80% discharged and with periodic equalizing charges. Let cool eight hours after charging before using.
2. Don't add acid to a battery. Only a person trained and qualified to do battery maintenance should determine if this is necessary.
3. Lift battery only with a correctly-constructed lifting device that will not put pressure on the battery case.
4. Keep open flames, tools, and metal objects away from the top of battery to prevent short circuits and explosions.
5. Do not overcharge.
6. Check the battery electrolyte level **after** each charging. Add water if the top of the separator or plates are visible. **Do not overfill!**
7. **Keep the battery clean and dry.** Wash down as needed.
8. Keep battery service records.

Battery Installation

1. Use only a lead-acid battery with the voltage and ampere-hour rating specified for the truck.
2. When changing batteries on battery electric trucks, replacement batteries must be of the service weight that falls within the minimum/maximum range specified on truck nameplate.
3. Be sure truck is properly positioned and parking brake applied.
4. Handle battery only with approved lifting device.
5. Install the battery correctly in the truck and secure it in position.

NOTICE

Some trucks are equipped with battery stops or blocks. Others do not require them. If the truck being serviced has battery stops or blocks, be sure none are missing or damaged. Replace them as necessary. If they are an adjustable type, be sure they are correctly adjusted and tightened. There should be no more than 1/2" total clearance around the battery. The battery weight must be within the range specified on the truck nameplate.

Specifications

Clark products and specification are subject to improvements and changes without notice or obligation.

Model Designation — Rated Load Capacity

TMG 12	2,500 lbs	@	24 in	[1250 kG @ 500 mm]
TMG 15S	3,000 lbs	@	24 in	[1500 kg @ 500 mm]
TMG 15	3,000 lbs	@	24 in	[1500 kg @ 500 mm]
TMG 17	3,500 lbs	@	24 in	[1750 kg @ 500 mm]
TMG 20	4,000 lbs	@	24 in	[2000 kg @ 500 mm]
TMG 25	5,000 lbs	@	24 in	[2500 kg @ 500 mm]

Note: Specifications are given with triple stage upright, standard battery compartment size and minimum battery weight.

Truck Weights (approximate, with TSU upright and minimum battery weight)

	<i>Gross Vehicle Weight (lbs)</i>	<i>Empty Vehicle Weight (lbs)</i>	<i>Loaded Drive Axle (lbs)</i>	<i>Empty Drive Axle (lbs)</i>
TMG 12	9948	7448	9005	4411
TMG 15S	11022	8022	9903	4390
TMG 15	10771	7771	9534	4341
TMG 17	11597	8097	10407	4348
TMG 20	12671	8671	11255	4330
TMG 25	14684	9684	12949	4268

Wheels & Tires

	<i>Drive Tire Size: (Cushion/Pneumatic)</i>	<i>Steer Tire Size: (Cushion/Pneumatic)</i>	<i>Dual Steer Tire Size: (Cushion)</i>
TMG 12	18x7x12.12/18x7x8 16PR	18x7x12.12/18x7x8 16PR	15x5x11 1/4
TMG 15S	18x7x12.12/18x7x8 16PR	18x7x12.12/N/A	15x5x11 1/4
TMG 15	18x7x12.12/18x7x8 16PR	18x7x12.12/18x7x8 16PR	15x5x11 1/4
TMG 17	18x8x12.12/18x9x8 16PR	18x7x12.12/N/A	15x5x11 1/4
TMG 20	18x8x12.12/18x9x8 16PR	18x7x12.12/N/A	15x5x11 1/4
TMG 25 _(urethane)	18x9x12.12/N/A	18x6x12.12/N/A	N/A

Battery Capacity Range

13.75" Compartment 18 cells, 11 plate 600-775 AH@6hr rating 20.9-27.0 kWh@6hr rating	20.5" Compartment 18 cells, 17 plate 800-1240 AH@6hr rating 27.7-43.0 kWh@6hr rating	25.0" Compartment 18 cells, 21 plate 1000-1550 AH@6hr rating 34.7-53.8 kWh@6hr rating
---	---	--

Battery, fully charged: 1.275 specific gravity (1.310 Exide Load Hog)
Discharged: 1.140 specific gravity

Fill Capacities—Fluid Volumes

2 Drive Axle: 1.0gal (3.8L) each side.

Hydraulic Sump Tank (Useable Volume): 2.6 gal (9.84L)

Use genuine CLARK parts. See your CLARK dealer.

Hydraulic Fluid Recommendation

Normal application - Clark Specification MS-68 Hydraulic oil

Drive Axle Fluid Recommendation: AMACO 1000

Power Steering Fluid Recommendation Uses main hydraulic sump oil supply.

Brake Reservoir: DOT 3 Brake Fluid

Multi-Purpose Grease

Axle Ends, Wheel Bearings: NLGI Grade No. 1 Lithium soap base grease
CLARK Specification MS-9B and MS-107B.

Steering linkage, upright mast & carriage rollers, trunnion bushings, tilt cylinder rod ends, brake pedal shaft: NLGI Grade No. 2 Lithium soap base grease,
CLARK Specification MS-107C.

Index

A

- A message to CLARK lift truck operators ii
- Accelerator 5-7
- Adjusting the load forks 5-11
- Adjusting the seat 5-4
- After operating the truck 5-17
- Air cleaning the truck 7-20
- Attachments 5-13
- Auxiliary controls 7-16

B

- Battery
 - Capacity Range 8-1
 - Charging 5-5, 7-23
 - Cleaning and care 7-25
 - Handling 7-22
 - Installation 7-26
 - Level 3-11
 - Maintenance 7-21
 - Maximum battery life 7-26
 - Removal from truck 7-24
 - Service records 7-25
 - Status 3-10
- Before operating the truck 5-2
- Brake Reservoir 8-2
- Braking 5-7
- Buckling up 5-4

C

- Capacity of truck 1-14
- Capacity plate 3-4
- Chain slack 2-7, 5-12
- Classified area 5-11
- Command system(option) 3-9
- Concluding the Inspection 4-5
- Controlling speed 5-7
- Critical fastener checks 7-19

D

- Daily inspection 1-2
- Daily maintenance checks 7-4
- Daily safety inspection 4-1
- Dash display 3-8
- Data plate 3-4
- Decals
 - Battery connector 3-6
 - Keep away, forks 3-6
 - Safety warning 3-3
 - Tip-Over warning 3-5
 - Upright warning 3-6
- Direction control lever 3-8
- Do's and don'ts 1-3
- Driver's daily checklist 4-2, 4-5
- Drive motor brush wear 3-10
- Drive motor overload 3-11
- Drive motor temperature 3-11
- Drop-offs 2-5

E

- Emergency towing 6-1

F

- Fast turns and high loads 2-4
- Fill Capacities 8-2
- Fluid Recommendations
 - Drive Axle 8-2
 - Hydraulic 8-2
 - Power Steering 8-2
- Forks 7-13
- Fork positioning 5-6
- Fork safety 1-8
- Fork wear and damage 7-13
- Functional checks 4-4
- Functional tests 7-14

G

- General safety rules 1-1
- Grades, ramps, slopes, and inclines 1-11

- H**
- Hour meter 3-10
 - Hour reading, digital 5-5
 - How to Get Maximum Battery Life ..
..... 7-26
 - Hydraulic fluid check 7-19
- I**
- Inclines 1-11
 - Inspection interval 4-2
 - Inspecting your truck 4-2
 - Introduction vi
- K**
- Key switch 3-7
- L**
- Leaking hydraulic oil 4-2
 - Lift truck parking 6-3
 - Load handling 5-12
 - Long and wide loads 2-3
 - Long loads 2-3
 - Loose Loads 2-2
 - Low overhead clearance 2-4
- N**
- No riders 1-5, 5-9
- M**
- Model Designation 8-1
 - Moving loads 5-14
 - Multi-Purpose Grease 8-2
- O**
- Operator compartment layout 3-7
 - Operator daily Inspection vii
 - Operating hazards 2-1
 - Operating procedures 5-1
 - Operator Protection 1-7
 - Overhead guard 1-7
 - Out of service tag 4-5
- P**
- Pallets 2-8
 - Pallets and Skids 2-8
 - Parking 1-15, 4-4
 - Parking Brake 3-10
 - Pedestrians 1-6
 - Performance Mode Levels 3-11
 - Performance Selector Button ... 3-11
 - Pinch Points 1-9
 - Pinch points 1-9
 - Planned Maintenance vii, 3-10
 - Power steering, disabled 6-3
 - Publications, related
 Service Manual vii
 - Pump Control Temperature 3-11
 - Pump Motor Brush Wear 3-10
 - Pump Motor Temperature 3-10
- R**
- Ramps 1-11
 - Rated Load Capacity 8-1
 - Rear Swing 2-3
 - Repairs 4-2
 - Riders 1-5
 - Right-Angle Stacking 2-6
- S**
- Safety inspection, daily 1-2
 - Safety messages x
 - Safety signs x
 - Safety rules 1-1, 2-1
 - Safety Signs and
 Safety Messages x
 - Seat Belts 1-4, 3-10
 - Service Manual vii
 - Service Status 3-10
 - Skids 2-8
 - Slopes 1-11
 - Stored Status Code Button 3-11
 - Surface and Capacity 1-14
 - Surface, hazards 1-14

T

Tipover	1-12
Towing Precautions	6-2
Traction Control Temperature ..	3-11
Travel	1-10
Truck Model Description	3-2
Truck Weights	8-1

U

Upright Positioning	5-6
---------------------------	-----

V

Visual Checks	4-3
---------------------	-----

W

What to do in Case of a tip-over	1-13
Wheels & Tires	8-1
Wide loads	2-3

Additional copies of this manual may be purchased from
YOUR AUTHORIZED CLARK DEALER



CLARK® Material Handling
Company

Lexington, Ky. 40508
Printed in USA